

Linear bearings and units

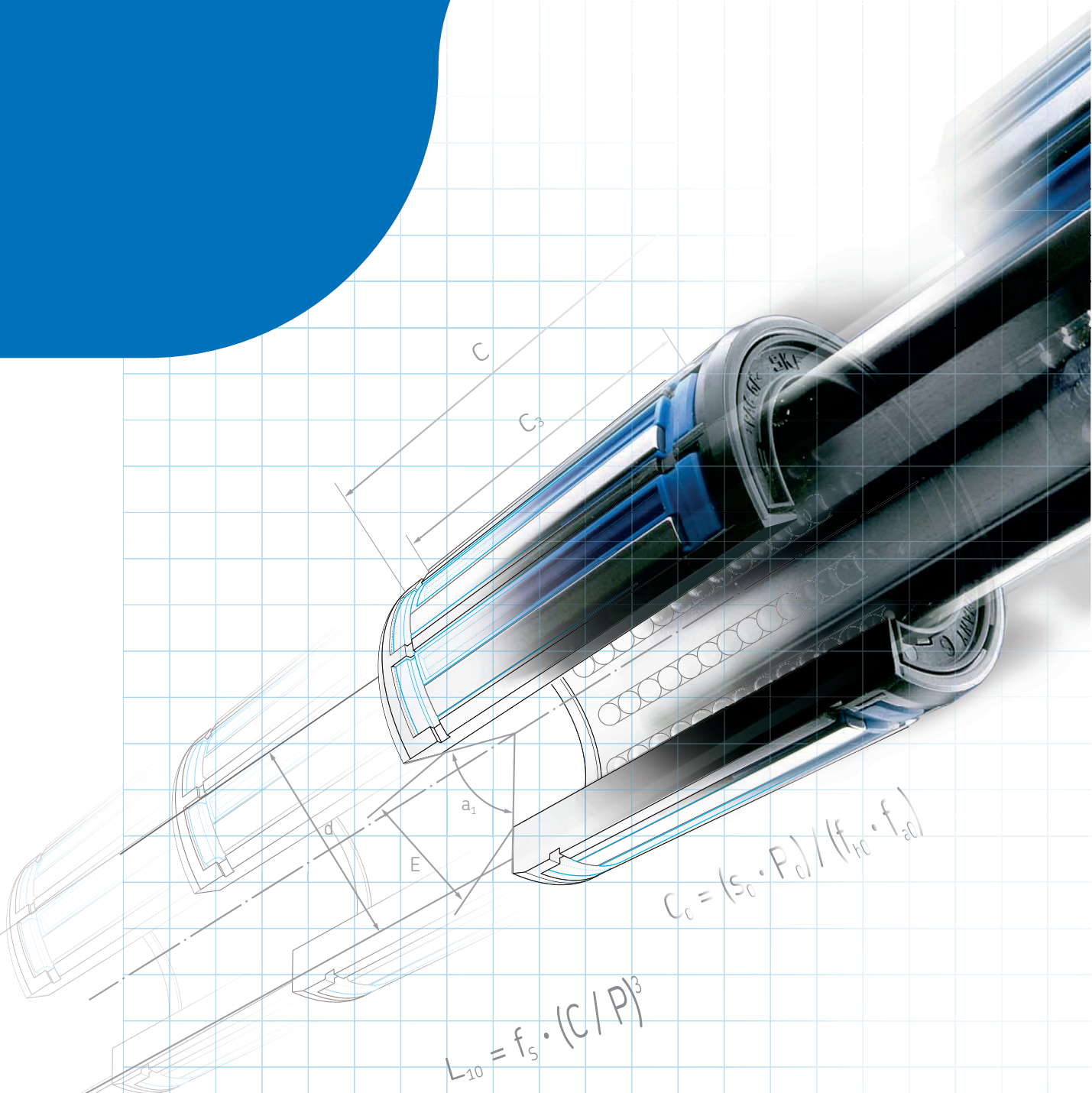

Technical handbook





The SKF® brand now stands for more than ever before, and means more to you as a valued customer.

While SKF maintains its leadership as the hallmark of quality bearings throughout the world, new dimensions in technical advances, product support and services have evolved SKF into a truly solutions-oriented supplier, creating greater value for customers.

These solutions encompass ways to bring greater productivity to customers, not only with breakthrough application-specific products, but also through leading-edge design simulation tools and consultancy services, plant asset efficiency maintenance programmes, and the industry's most advanced supply management techniques.

The SKF brand still stands for the very best in rolling bearings, but it now stands for much more.

SKF – the knowledge engineering company

Foreword

This handbook brings together all the basic data, as well as useful advice on the operation and mounting of linear guide systems incorporating linear ball bearings, linear plain bearings, profile rail guides and precision rail guides. All products described here are included in the SKF product range and are obtainable through the usual sales network.

Individual products selected according to the calculation methods described in this handbook can be identified in the appropriate catalogue according to their product designation.

All data in this catalogue are based on 2000 design and manufacturing standards. Static load ratings are calculated according to the current DIN definition. Previous catalogues are superseded by this edition. The right is reserved to make changes necessitated by technological developments.

SI (Système International d'Unités) units in accordance with ISO Standard 1000-1981 are used in this catalogue. Relevant conversion factors are given in the following:

Length

$$1 \text{ mm} = 0,03937 \text{ inch}$$

$$1 \text{ inch} = 25,4 \text{ mm}$$

Pressure

$$1 \text{ MPa} = 1 \text{ N/mm}^2 = 10 \text{ bar}^1$$

Kinematic viscosity

$$1 \text{ mm}^2/\text{s} = 1 \text{ cSt}^1$$

¹⁾ The units "bar" and "cSt" are given for comparative purposes only and are no longer used commercially.

Content

Linear guidance systems

General	6
Principles of selection	7
Load carrying capacity	7
Cross section and available space	7
Linear running accuracy	8
Speed and acceleration	8
Stiffness of linear rolling guides	9
Standardisation	9

Basic technical principles for linear rolling bearings

Basic technical principles	10
Definitions	10
Forces, moments and coordinates	10
Forces at carriages/tables with 4-fold support	10
Life	11
Service life	11
Basic rating life L	11
Total life L_{ges}	11
Basic dynamic load rating C	11
Influence of stroke length, factor f_s	11
Effective dynamic load rating C_{eff}	12
Influence of raceway hardness, factors f_h and f_{h0}	13
Influence of the number of loaded bearings, factors f_i and f_{i0}	13
Permissible dynamic moments M_{max}	14
Equivalent dynamic bearing load P	14
Influence of direction of load, factors f_i and f_{i0}	14
Influence of misalignment, factors f_m and f_{m0}	14
Influence of operating temperature, factors f_t and f_{t0}	14
Determination of mean load	15
Factor f_d for load conditions	16
Dynamic and static load fluctuation factors f_T and f_{T0}	16
Basic static load rating C_0	17
Static load carrying capacity	17
Permissible static moments $M_{0,max}$	17
Effective static load rating $C_{0,eff}$	17
Equivalent static bearing load P_0	18
Static load safety s_0	18
Osculation φ	18
Life calculation	18
Adjusted rating life	19
Factor c_1 for reliability	19
Factor c_2 for operating conditions	20
Running accuracy of linear rolling guides	21
Stiffness of linear rolling guides	21
Permissible operating conditions	21
Permissible maximum load	22
Requisite minimum load	22
Permissible operating temperature	22
Permissible speed and acceleration	22
Requisite minimum stroke	22
Stationary conditions	22
Friction	22

Lubrication	23
Grease lubrication	23
Lubricating greases	23
Base oil viscosity	23
Consistency	23
Temperature range	23
Protection against corrosion; behaviour in the presence of water	24
Load carrying capacity	24
Miscibility	24
Lubricating greases from SKF	25
Relubrication intervals	25
Relubrication	26
Replenishment	26
Lubrication nipple	26
Oil lubrication	26
Lubricating oils	26
Selection of lubricating oil	26
Mounting	27
Preparation for mounting	27
Storage of linear bearings	27
Cleaning of linear bearings	27
Sealing	28
Linear ball bearings	
Bearing types	29
LBBR linear ball bearings	29
Stainless	30
LBCR and LBCE linear ball bearings – closed design	30
LBCT, LBHT and LBCF linear ball bearings – open design	30
Basic technical principles	31
Definitions	31
Load ratings	31
Osculation ϕ	32
Life	32
Life calculation	32
Influence of raceway hardness, factor f_H	32
Equivalent dynamic bearing load P	33
Influence of direction of load, factors f_t and f_{t0}	33
Influence of misalignment, factor f_m	34
Static load carrying capacity and equivalent static load	34
Requisite basic static load rating and verification of static load carrying capacity	35
Stiffness of linear ball bearing guides	35
Calculation example	36
Tolerances	39
Dimensional and form accuracy of bearing housing	39
Roughness of bearing seating surfaces	39
Operating clearance	41
Calculation of operating clearance	41
Accuracy of linear ball bearing guides	41
Influence of mounting on accuracy of guidance	42
Permissible operating conditions	43
Permissible maximum load	43
Requisite minimum load	43
Permissible operating temperature	43
Permissible speed and acceleration	43

Stationary conditions	43
Friction	43
Factory pre-lubrication	44
Lubrication	44
Grease lubrication	44
Base oil viscosity	44
Consistency	45
Temperature range	45
Load carrying capacity	45
Relubrication intervals	45
Relubrication	46
Replenishment	46
Lubrication nipple	46
Oil lubrication	46
Lubricating oils	46
Selection of lubricating oil	46
Calculation example	47
Application of bearings	48
Radial location	49
Axial location	49
Axial location to prevent turning	51
Mounting	52
Adjustment of operating clearance	52
Mounting of linear ball bearings in guidance systems	53
Seals	54

Linear plain bearings for shaft guidance systems

Bearing types	55
LPBR linear plain bearings	55
LPAR and LPAT linear plain bearings	55
Basic technical principles	56
Load carrying capacity	56
Service life	56
“pv” load/speed relationship	56
Range of applications	57
Friction	57
Tolerances	57
Lubrication	59
Bearing arrangements	59
Housing and shaft tolerances	59
Mounting and dismounting	60

Linear guidance systems

General

Linear guidance systems are divided into two main types depending on their design. The first group comprises those which permit unlimited linear travel through the use of a rolling element recirculation system. This group consists of shaft guidance systems fitted with linear ball bearings and profile rail guides which may be regarded as a variant of the linear ball bearing.

These two guidance systems together cover a large part of market requirements in this field of application.

In addition to the rolling bearing types, a demand has recently arisen

for linear plain bearings having the same external dimensions as their rolling bearing equivalents. These have been designed for use in certain special applications.

In the second group are precision rail guides which, due to their internal design, require very little mounting space and enable very precise linear motion by virtue of special manufacturing techniques. However, they are only suitable for limited travel. Because of the large number of suppliers, there is no standardisation of the cross sectional area or abutment dimensions. Consequently there can be considerable problems when altering bearing arrange-

ments. SKF has therefore developed the "Modular range", consisting of guides with various rolling element assemblies, all with the same mounting dimensions. This range enables a simple adaptation of precision rail guides to differing demands in terms of running qualities, load carrying capacity or stiffness.

In order to give CAD system users the possibility of incorporating the various linear guidance systems in their designs, SKF offers the download of CAD data on the website www.linearmotion.skf.com.



Principles of selection

Each linear guidance system has its own characteristics which make it suitable for specific bearing arrangements. However, general rules cannot be given regarding the selection of a particular guidance system, because of the various interdependent factors that must be taken into consideration. The following information is intended to demonstrate the particular properties of the individual guidance systems and facilitate the choice between the different types of guides.

Load carrying capacity

The load carrying capacity of linear rolling bearings is largely determined by the contact between the rolling element and the rail. In linear carriage systems, where rolling bearings are used as cam rollers, the load carrying capacity usually depends on the incorporated bearings. In the first case the dynamic load rating is determined by the number of rolling elements in the load zone and their position relative to the direction of load. In contrast, the static load rating only relates to the most heavily loaded rolling element.

When calculating the dynamic and static load ratings, the conformity of rolling elements and raceway plays a decisive role, in particular the ratio between raceway radius and ball diameter, known as osculation. The corresponding characteristic for rollers with line contact is a logarithmic roller profile which avoids or minimises edge stressing in the rolling contact zone. Experience has shown, however, that even the optimisation of the outer ring raceway of a linear ball bearing results in a dynamic load rating increase of no more than 35 %.

For normal applications where, under low load conditions, the radial stiffness plays only a minor role, the closed design of a linear ball bearing

is recommended. The linear guidance system will thus be supported at the ends of the precision shaft by shaft blocks bolted to the appropriate machine parts.

Under conditions of high load, a suitable shaft support should be selected to support the shaft along its entire length of travel; a partial support is the exception. In such applications, open linear ball bearings should be used, segmented in the region of the shaft support and if possible loaded only in the direction of the main load.

Profile rail guides are, in the broadest sense, a further development of the supported linear ball bearing arrangement. The raceways of the four circulation paths are integrated in the slide unit which is also provided with fixing holes for the mounting of machine components. The profile rail has four ground raceways each with a ball-conforming profile for optimum rolling conditions. Fixing holes situated at a regular pitch enable direct attachment to the machinery housing. Because of the larger ball diameter and the greater number of loaded balls, the load carrying capacity of these linear systems is higher than those of comparable linear ball bearing units.

As is the case with linear ball bearing and profile rail guides, both single carriages and combinations of two carriages with one rail, as well as four carriages with two rails can be used.

Precision rail guides are precision rolling bearings for limited travel. They are suitable for incorporation into all kinds of machine tools, high-precision handling and positioning systems as well as work centres and test equipment. They are available in various sizes and standard lengths, fitted with ball, roller or needle roller units depending on the particular application. Their characteristic fea-

tures include high stiffness coupled with high load carrying capacity for a small cross sectional area.

Cross section and available space

Apart from the load carrying capacity of a linear guidance system the space requirements for mounting are also of major importance. In order to clarify the relationship between load rating and mounting height, a linear axis with 500 mm travel has been selected as a basis for the diagram shown in fig 1.2. Precision rail guides also fit into this concept. Here it should be recognised that rail guides with needle roller or crossed roller assemblies possess the highest load carrying capacity for a given mounting space. Profile rail guides and precision rail guides with ball assemblies are of practically equal proportions. The most space is required by linear ball bearing units.

Fig. 1.2

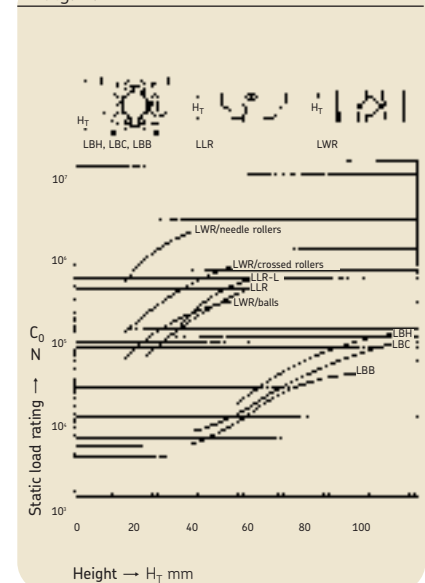

Linear running accuracy

The required running accuracy is of principal importance when selecting linear guidance systems. In linear rolling guides it is determined by the manufacturing tolerance of the raceway on one hand and by the precision of the adjacent components and mounting accuracy on the other. Different guidance accuracies can be achieved depending on the guidance system used.

Whereas in the case of handling systems an accuracy in the order of 1 to 0,1 mm is expected, machine tool applications usually call for anything from 10 to 1 μm . For measuring equipment and metal cutting machines these limits may be even tighter.

Where linear ball bearings are concerned the geometry of the shaft and mounting influences also play a considerable role.

On account of their design, profile rail guides offer higher running accuracy which, depending on the material, may reach 6 μm per 1 000 mm of length.

Precision rail guides are manufactured with even higher accuracy. Three alternative grades are available, the highest of which offers a parallelism of 2 μm per 1 000 mm length.

Speed and acceleration

The suitability of a given linear guidance system for high speed is determined by the rolling qualities of the elements during acceleration. As a

basic rule, the higher the acceleration or deceleration, the greater the preload of the linear rolling bearing. In unloaded conditions only preload ensures the smooth rolling of the rolling element. It is basically impossible to cite any particular guidance system as being superior to the others without knowing the precise operating conditions. The most important factor in selecting a linear guidance system is its ability to match the preload to the operating conditions. Fig 1.3 shows the most common fields of application with the various linear guidance systems as well as the required positioning accuracy and running speed. These should be taken only as a rough selection guide for similar applications.

Fig. 1.3

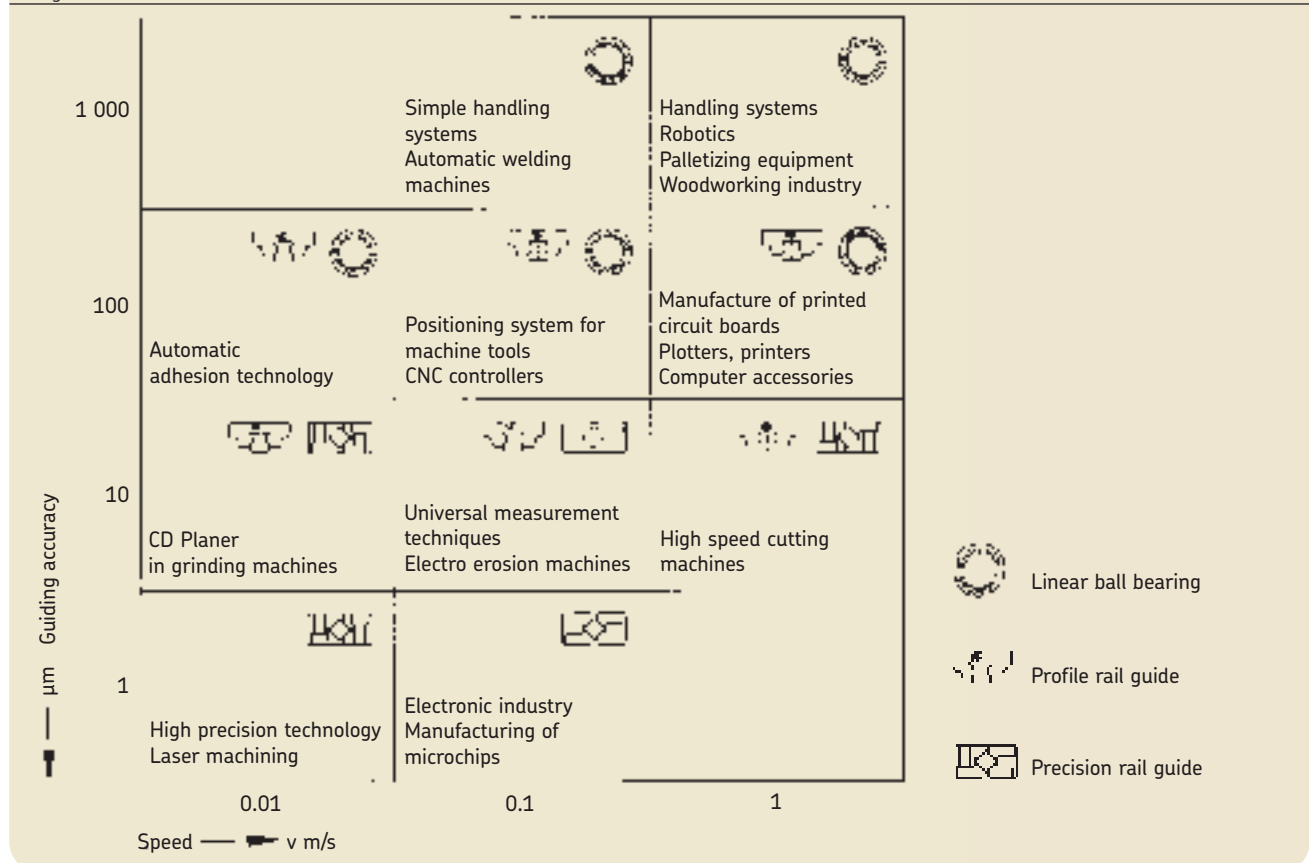

Stiffness of linear rolling guides

In addition to load carrying capacity, the stiffness, or its reciprocal elasticity, is another important aspect for selecting the most suitable linear guidance system. By definition stiffness is the ratio of load to deflection, usually measured at the point of load application and in load direction. The deflection of the individual guide elements normally results in the total deflection. Parallel and series connection of the individual elements have to be taken into consideration. The calculated or measured stiffness of the guidance system can thus be much lower than the stiffness in the rolling contact zone.

Due to the contact conditions between rolling elements and raceways, linear guidance systems with cylindrical or needle rollers offer greater stiffness than those incorporating balls.

The elastic deformation of the linear rolling bearings can often be indicated as a function of the static load rating C_0 and relate to zero-clearance guides if not stated otherwise. If radial clearance occurs for reasons of mounting, greater elastic

deformation must be expected as there is a smaller number of rolling elements in contact. If necessary the radial clearance should be included in the calculation as reverse clearance. With preloaded guides however the elastic deformation is smaller, i.e. the stiffness is higher than with zero clearance.

The overall system stiffness can be determined either by complex direct load measurements (laser systems), or with the help of vibration measurements e.g. by measuring the frequency compliance.

Fig 1.4 serves to provide a comparison of the stiffness of various linear guidance systems.

Standardisation

In contrast to rolling bearings, adequate standardisation of linear guidance system has only just begun. The main points of the standardisation programme are as follows:

Linear ball bearings

Under ISO 10 285, currently used linear ball bearings are classified into four groups and categorised according to their external dimensions and tolerances.

Accessories for linear ball bearings

Accessories such as shafts, shaft supports, shaft blocks and housings are included under the published recommendations of ISO DIS 13 012.

Load ratings of linear rolling guides

The bases for calculating the load ratings and life of the various linear bearing systems are laid down in the following ISO standards:

ISO 14 728,

Part 1: Calculation of basic dynamic load ratings and life

ISO 14 728,

Part 2: Calculation of basic static load ratings

With the aid of these ISO standards, a uniform calculation method has been laid down, enabling the establishment of the basic dynamic and static load ratings as well as the life of linear guidance systems.

Form and dimensional tolerances

DIN 69056,

Part 1: Rails for linear guides (precision rail guides)

DIN 644: Guideways for linear bearings, dimensions and tolerances

Fig. 1.4

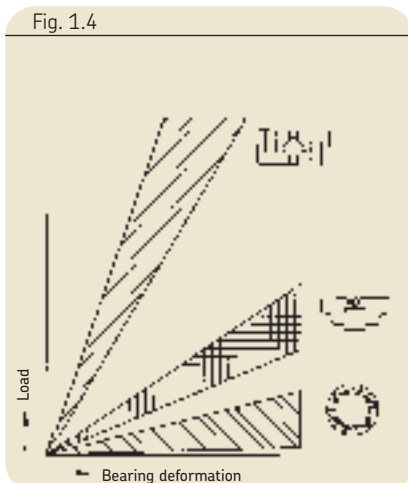

Basic technical principles for linear rolling bearings

Basic technical principles

It is not always possible to select the most suitable linear ball bearing for a given application by experiment. Instead, the following well-trying procedures are recommended:

- life calculation under dynamic operating conditions
- static safety load calculation under static operating conditions

The life of a linear rolling bearing is defined as the distance covered between the guidance elements before the first sign of material fatigue occurs on one of the raceways and/or the rolling elements.

The static load safety, expressed as the ratio between the basic static load rating and the static equivalent load, gives the degree of safety against excessive permanent deformation of the rolling elements and raceways. Experience shows that a total permanent deformation can be allowed of 0,0001 of the rolling element diameter at the centre point – which is the most heavily loaded point of contact in most applications – without impairing the functioning of the linear bearing.

Linear rolling bearings are standardised in the majority of cases. Usually this is also the case with the methods for calculating the load ratings as well as the basic rating life, i.e. the life achievable by a linear rolling bearing with a 90 % degree of certainty with today's manufacturing materials of normal product quality and under normal operating conditions. This usually also includes the calculation of the static load ratings.

Not all linear rolling bearings or guide elements available on the market today have been standardised yet. This also applies to the cal-

culaton of the dynamic and static load ratings. In such cases the catalogue values are based on generally accepted calculation methods for rolling bearings.

Definitions

Forces, moments and coordinates

When determining the support forces of a carriage or the carriage forces of a complete table/slide from the external forces or mass forces, it is important to choose a suitable system of coordinates. It is recommended to pinpoint the centre of the carriage or table as its origin. The x-axis represents the direction of movement, the y-axis is situated at a right angle relative to the x-axis and the z-axis is positioned vertically to this plane.

These forces are indexed by their directions of effect; however there are also further differentiations into vertical forces $F_v = F_z$ and horizontal forces $F_H = F_x$. According to the rules of mechanics, an eccentric force is defined as a moment around its rotary axis plus centrally applied individual load. For example, a vertical force F_z acting on a lever arm y becomes:

$$(2.1) \quad F_z \cdot y = M_x + F_z$$

This means that a force applied to a lever arm y in z direction is equivalent to a pure moment around the x -axis while taking into consideration the centric force F_z .

The preceding signs for the lever arms, forces and moments are often selected simply for practicality rather than in the conventional theoretical sense.

Forces at carriages/tables with fourfold support

Apart from simple load cases and approximation values, the equivalent dynamic and static loads acting on a carriage (or a slide or table) supported by four linear ball bearings or other rolling elements such as LLR profile rail guide carriages, can only be determined by calculating the forces in y/z direction at the individual supports. Especially where different load cases are encountered along the full stroke, i.e. distances of acceleration and deceleration with intermediate sections of constant speed and where the proportions of time are known, a calculation via the individual supports is recommended.

A system considered is subject to external loads according to fig. 2.1. The definitions regarding position, direction and sense of rotation are arbitrary and deviate from the right-hand rule but enable a simple calculation by hand or the development of a corresponding calculation program as well as a simple verification.

For illustration let us treat the top view of the carriage surface as an analogue clock-face according to fig 2.1. This will show the following support arrangement:

The distance between the outer supports in x direction (direction of travel), i.e. support 1 to support 3 and support 2 to support 4, be l_x ; the effective rail distance in the case of a table or slide or the distance between the roller supports in a carriage in y direction be l_y ; the z direction be the vertical distance and the coordinate origin be positioned symmetrically in the rail guide plane.

Fig. 2.1 Schematic representation of a carriage incl. definition of directions

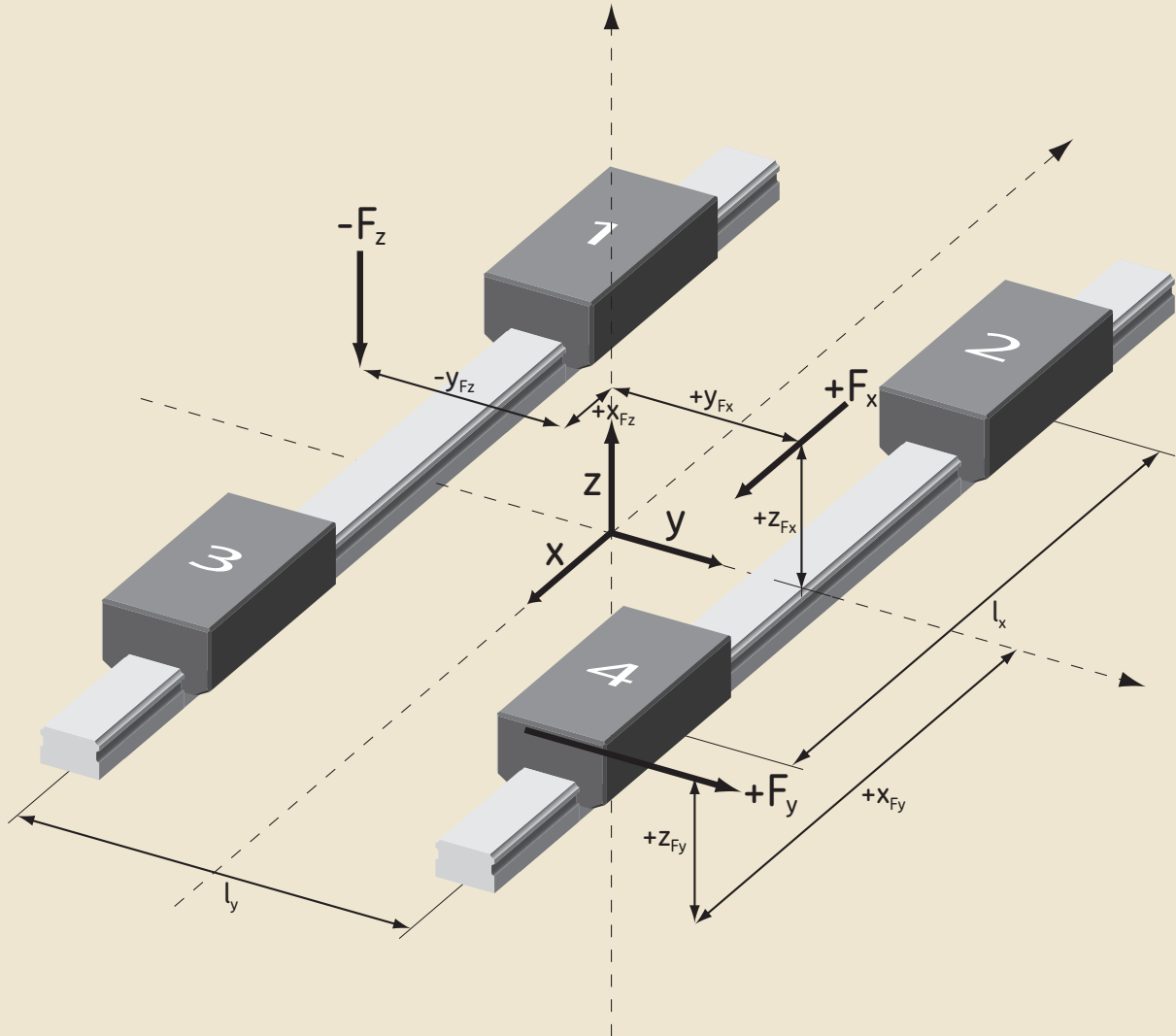

The following forces and coordinates or lever arms be positive (see fig. 2.1):

- x 6 o'clock
- y 3 o'clock
- z above the x/y plane
- F_x acting in 6 o'clock direction
- F_y acting in 3 o'clock direction
- F_z direction from x/y plane

Vertical support forces F_v of the carriage as resultant forces:

According to the enumeration above (the order of the preceding signs corresponds to the indexation of F_v), the vertical support forces in z direction as resultant forces can be obtained from:

$$(2.2) \quad F_{v(1,2,3,4)} = \sum F_{z,i} \cdot (0,5 - y_{Fz,i} / l_y) \cdot (0,5 - x_{Fz,i} / l_x) + \sum F_{y,j} \cdot (-y_{Fy,j} / l_y) + \sum F_{x,k} \cdot (-x_{Fx,k} / l_x)$$

The order of the preceding signs relates to the supports 1, 2, 3 and 4.

- $F_{v1...4}$ Vertical support forces as resultant forces
- $F_{z,y,x}$ External forces acting in z/y/x direction
- i_z, j_y, k_x Number of external forces acting in z/y/x direction

Forces acting in y direction depend on the type of rail support.

Life

The life of a linear ball bearing is defined as the distance travelled (or the number of operating hours/strokes at constant stroke length and frequency) by the bearing before the first sign of material fatigue (spalling) appears on the raceway or rolling elements.

However both in laboratory trials and in practice it is found that the life of apparently similar bearings under completely identical running conditions can differ. Calculation of the appropriate bearing size therefore requires a full understanding of the concept of bearing life. All references to the dynamic load rating of SKF linear ball bearings apply to the basic rating life, as covered by the ISO definition, in which the life is understood as that reached or exceeded by 90 % of a large group of identical bearings. The majority of the bearings reach a longer life and half the total number of bearings reach five times the basic rating life.

Service life

The term “service life” is understood as the period of time for which a given linear bearing remains operational in a given set of operating conditions. The service life of a bearing therefore depends not necessarily on fatigue but also on wear, corrosion, seal failure, lubrication intervals (grease life) etc. Normally the service life can only be quantified in tests under realistic operating conditions.

Basic rating life L

The basic rating life is the life that 90 % of a sufficiently large group of apparently identical linear rolling bearing can be expected to attain or exceed under identical operating conditions.

Total life L_{ges}

If a number of i individual rolling elements of a given unit have a basic rating life L_i they will attain a total life of:

$$(2.3) \quad 1 / L_{ges}^\beta = 1 / L_1^\beta + 1 / L_2^\beta + \dots + 1 / L_i^\beta$$

If the equivalent dynamic loads for the individual rolling elements have already been calculated, the total life for i identical rolling elements with the dynamic load rating C is obtained from:

$$(2.4) \quad L_{ges} = C^p / [\sum P_i^{(\beta \cdot p)}]^{(1/\beta)}$$

Exponent β of the two-parameter Weibull distribution is usually set at 10/9, sometimes $\beta = 9/8$ is also used, where p is the life exponent ($p = 3$ for ball bearings, $p = 10/3$ for roller bearings).

Basic dynamic load rating C

According to the ISO definition the basic dynamic load rating C is the radial load, constant in magnitude and direction, which a linear rolling bearing can theoretically bear for a basic rating life of 100 000 m of travel. The basic dynamic load rating is based on the assumption that the stroke of the linear rolling bearing for elements with theoretically unlimited stroke, such as linear ball bearings or profile rail guides, is at least the length of the bearing or, for elements with limited stroke, such as precision rail guides, corresponds to at least the cage length. A lower limit for the validity of the dynamic load rating occurs with oscillating movements, i.e. when the stroke is shorter than the distance between the rolling elements. In such cases the raceway sections between the rolling elements are not rolled over so that a reformation of the lubricant film does not take place.

When determining the basic rating life L , the influence of a shorter stroke is taken into consideration with factor f_s .

$$(2.5) \quad L = f_s \cdot (C / P)^p$$

Influence of stroke length (factor f_s)

Extensive endurance tests and experience from practical operation have shown that the life of shafts/rails is shorter than the life of the linear rolling bearings when the stroke length is short. This is in particular true of linear ball bearings where the load carrying capacity of the shaft is of overriding importance. Table 2.1 shows the f_s values of linear ball bearings as a ratio of the single stroke l_s and the support length l_t of the rolling element.

Table 2.1: Factor f_s as a ratio of the l_s/l_t ratio (for linear ball bearings)

l_s / l_t	$f_{s,ball}$
1,0	1,00
0,9	0,91
0,8	0,82
0,7	0,73
0,6	0,63
0,5	0,54
0,4	0,44
0,3	0,34
0,2	0,23
0,1	0,13

Table 2.2: Support length l_t of the different linear ball bearings

Type	l_t	Type	l_t
LBBR 3	4,1	LBC ... 5	11,3
LBBR 4	5,4	LBC ... 8	12,5
LBBR 5	7,1	LBC ... 12	19,8
LBBR 6	12	LBC ... 16	22
LBBR 8	12,7	LBC ... 20	27,8
LBBR 10	12,7	LBC ... 25	39,6
LBBR 12	15,4	LBC ... 30	47,7
LBBR 14	15,4	LBC ... 40	54
LBBR 16	15,4	LBC ... 50	68,5
LBBR 20	15,4	LBC ... 60	92
LBBR 25	22,4	LBC ... 80	122
LBBR 30	32		
LBBR 40	38,6		
LBBR 50	47,8		

Effective dynamic load rating C_{eff}

The dynamic load rating values given in the SKF linear rolling bearing tables are valid for a direction of load which correspond to the maximum load carrying capacity of the bearings operating under optimum conditions. To take into account operating conditions which differ from this optimum, it is necessary to modify the basic dynamic load rating by a number of factors to give an effective dynamic load rating which is then inserted in the life equation.

These factors influencing the basic dynamic load rating C include the direction of load, the hardness of the raceways and the number of loaded bearings. For various linear rolling bearings, the reciprocal values were often used for the determination of the equivalent dynamic load P . This is attributable to the history of these products and the varying degree of standardisation.

$$(2.6) \quad C_{eff} = f_h \cdot f_i \cdot C$$

where

C_{eff} effective dynamic load rating, N

f_h factor for surface hardness of shaft

$f_i = i^w$, factor for number of loaded bearings, $w = 0,7$ for ball bearings, $w = 7/9$ for roller bearings

C basic dynamic load rating, as shown in the corresponding SKF linear bearing catalogues, N

Influence of raceway hardness

(factors for raceway hardness f_h and f_{h0})

This factor is primarily applicable when softer-than-usual steel shafts are used with linear ball bearings. Steel shafts for linear guidance systems should, like the raceways of linear ball bearings, be hardened and ground. The surface hardness should be at least 58 HRC and the mean surface roughness R_a meas-

ured to DIN 4768, Part 1, should never exceed $0,32 \mu\text{m}$. If shafts with a lower surface hardness are used, the factor f_h obtained from equation 2.7 has to be taken into consideration when calculating the effective dynamic load rating.

Lower surface hardness also influences the basic static load rating C_0 . Values shown in the catalogue should be corrected using the factor f_{h0} .

The reduction in dynamic and static load carrying capacity can be determined using the following equations where HV represents the Vickers hardness of the given material.

$$(2.7) \quad f_h = (HV / 655)^2$$

$$(2.8) \quad f_{h0} = (HV / 555) - 0,17$$

Equation 2.7 and 2.8 are valid in the given hardness range according to table 2.3. For values $> 700 \text{ HV}$ (59 HRC) f_h and f_{h0} become 1,0. For

Table 2.3: Comparison of hardness. Vickers hardness HV (to ISO 409) and Rockwell C hardness to Euronorm

HV	HRC	f_h	f_{h0}
430	44	0,44	0,61
440	45	0,46	0,63
455	46	0,49	0,65
470	47	0,52	0,68
480	48	0,55	0,71
500	49	0,58	0,73
510	50	0,62	0,76
530	51	0,66	0,79
545	52	0,69	0,82
560	53	0,74	0,85
580	54	0,78	0,88
600	55	0,83	0,92
620	56	0,88	0,95
640	57	0,93	0,99
675	58	1,0	1,0
700	59	1,0	1,0

values $< 430 \text{ HV}$ (44 HRC) please consult SKF.

Influence of the number of loaded bearings (factor f_i)

As linear rolling bearings are nearly always mounted in pairs or in greater numbers, the effective dynamic load rating of each bearing arrangement consisting of a given number i of identical bearings subject to identical loads is influenced by the factor f_i which is calculated as follows:

$$(2.9) \quad f_i = i^w / i$$

where

f_i factor for the load rating of a symmetrically loaded bearing arrangement consisting of a number i of identical bearings per shaft or per rail

w life exponent balls $w = 0,7$
rollers $w = 7/9$

The factor f_i is a statistical quantity which is calculated from the failure probability for a given number i of identical linear rolling bearings (rolling bearings in general). Manufacturing inaccuracies that would impair the even load distribution would further reduce the factor f_i . They should however be taken into consideration via the factor f_m for misalignment. In SKF linear bearing units the factor f_i has already been taken into consideration and is therefore set at 1 in further calculations. Only load cases characterised by extreme deviations in the loading of the individual linear rolling bearing should be calculated based on the load rating of the single bearing.

Table 2.4: Factor f_i for the dynamic load rating

No. of bearings	Balls	Rollers
1	1,00	1,00
2	0,81	0,86
3	0,72	0,78
4	0,66	0,74

Permissible dynamic moments M_{max}

The dynamic moments $M_{x,max}$, $M_{y,max}$ and $M_{z,max}$ complement the basic dynamic load rating C. As pure moments around the x, y or z axes they are parameters of the reliable dynamic load carrying capacity, in particular for profile rail guide carriages, but also for precision rail guide tables. Like the basic load rating C they relate to 100 km travel and a failure probability of 10 %.

Equivalent dynamic bearing load P

The equivalent dynamic bearing load is the constant radial load in magnitude and direction under the influence of which a linear ball bearing would reach the same basic rating life as under the actual load conditions. The equivalent dynamic bearing load should not exceed a value $C/2$ or the static load rating C_0 .

In case that one or even both of these conditions may occasionally not be met in your specific application, please contact SKF.

If the load F acting on the linear rolling bearings corresponds to the requirements for the basic load rating C, then $P = F$ and the load can be inserted directly into the life equation.

In all other cases it is necessary to calculate an equivalent dynamic bearing load. This is defined as that hypothetical load which will have the same effect, if applied, as the actual loads to which the bearing is subjected under the given conditions.

In cases where the loads F do not act centrally in z direction and/or where the misalignment between rail and rolling element exceeds the degree permissible for determining the load ratings, the external loads have to be corrected by appropriate factors.

$$(2.11) \quad F_{\text{equi}} = P = \frac{f_t \cdot F}{f_l \cdot f_m}$$

where

F_{equi} load F to be taken into consideration in the further calculation

f_l factor for direction of load, N

f_m factor for misalignment

f_t factor for operating temperature

Influence of direction of load

(factors f_l and f_{l0})

Numerical values, formulas or diagrams are included for the various product groups, in particular for linear ball bearings and profile rail guides. As a rule these relate to centric forces acting in the y/z plane.

Influence of misalignment

(factors f_m and f_{m0})

Where linear guides have no support for the guide shaft, shaft deflection may occur which can cause misalignment of the shaft in the bearing with respect to the bearing axis. Such misalignment causes an uneven distribution of load within the linear rolling bearing which must be taken into account using the factors f_m and f_{m0} . The inclination of the shaft in the centre of the bearing caused by the load can be calculated using the accepted equation for the deflection of a straight rod.

In addition to the bearing type, the factors f_m and f_{m0} are also dependent on the magnitude of bearing clearance. Low radial clearance and in particular preload will lead to reduced values. Increased elasticity of the tables can also improve the load distribution in the bearings and thus result in reduced factors.

Influence of operating temperature

(factors f_t and f_{t0})

At a normal room temperature between 15 °C and 30 °C, linear rolling bearings seldom reach more than 50 °C temperature due to inherent heat.

Table 2.5: Influence of operating temperature (°C)

t	f_t / f_{t0}
125	1,01
150	1,04
175	1,09
200	1,17
225	1,26
250	1,38

Elevated operating temperatures are normally the result of higher ambient temperatures. For an operating temperature t in °C and $t > 100$ °C:

(2.12)

$$f_t = f_{t0} = 1 + (t - 100)^2 / 60\,000$$

Normally linear rolling bearings can be used without restrictions up to temperatures of +80 °C. This also applies to bearings with plastic cages and elastic seals. Linear rolling guides with metal cages and end pieces can usually be used at temperatures of up to 120 °C; even higher temperatures of up to 150 °C are tolerable for brief periods, assuming both sufficient viscosity of the lubricant and appropriate relubrication intervals. (See also factor c_2 for operating conditions).

Permanently higher operating temperatures will however lead to changes in the material structure resulting in inadmissible dimensional changes. Moreover the hardness of the material and thus the load carrying capacity of the guide elements will decrease by a certain degree. In such cases, the hardness reducing factors f_h and f_{h0} have to be taken into consideration.

Determination of mean load

For a mean load F_m with time variable forces $F(t)$ and speed $v(t)$:

$$(2.13) F_m = (I_f / I_v)^{1/p}$$

where

$$(2.14) I_f = \int_0^T v(t) \cdot F^p(t) dt$$

and

$$(2.15) I_v = \int_0^T v(t) dt$$

If, for instance, the load is made up of a number of forces which are of constant magnitude for a given stroke length, or if a fluctuating load can be approximately resolved into a number of constant single forces (fig 2.2), then the mean load can be determined approximately using:

$$(2.16) F_m = [(F_1^p \cdot s_1 + F_2^p \cdot s_2 + \dots + F_i^p \cdot s_i) / s]^{1/p}$$

or

$$(2.17) F_m = [(F_1^p \cdot v_1 \cdot t_1 + F_2^p \cdot v_2 \cdot t_2 + \dots + F_i^p \cdot v_i \cdot t_i) / s]^{1/p}$$

or

$$(2.18) F_m = [(F_1^p \cdot v_1 \cdot q_1 + F_2^p \cdot v_2 \cdot q_2 + \dots + F_i^p \cdot v_i \cdot q_i) / v_{m,p}]^{1/p}$$

using

$$(2.19) v_{m,p} = \frac{1}{T} \int_0^T v(t) dt = q_1 \cdot v_1 + q_2 \cdot v_2 + \dots + q_i \cdot v_i$$

where

F_m constant mean load, N

F_1, F_2 constant loads during stroke lengths $s_1, s_2 \dots, N$

With fluctuating forces within a given time t , it is also possible to use formula 2.20 or include the load deviation factors f_T given in table 2.7.

p life exponent:

ball $p = 3$; roller $p = 10/3$

q_1, q_2 proportion of time (< 1) of the given total period of time T

s total stroke length ($s = s_1 + s_2 + \dots$), during which loads F_1, F_2, \dots are applied, mm. The stroke length s itself may also be a part of the total stroke.

t time, also period of time t , s

T given total period of time, s

v speed, m/s

$v_{m,p}$ equivalent dynamic speed, m/s

If the stroke frequency is constant and the load is constant in direction but consistently fluctuates (sinusoidally or in linear direction) between a minimum value F_{min} and a maximum value F_{max} (fig. 2.3), the mean load can be obtained approximately from:

$$(2.20) F_m = (F_{min} + 2 \cdot F_{max}) / 3$$

Fig 2.2: Mean load F_m with variable forces over a (partial) stroke

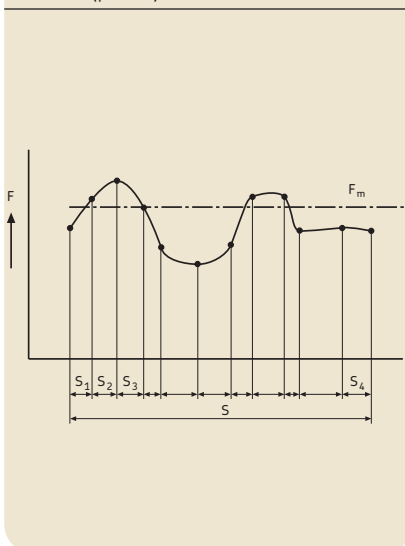
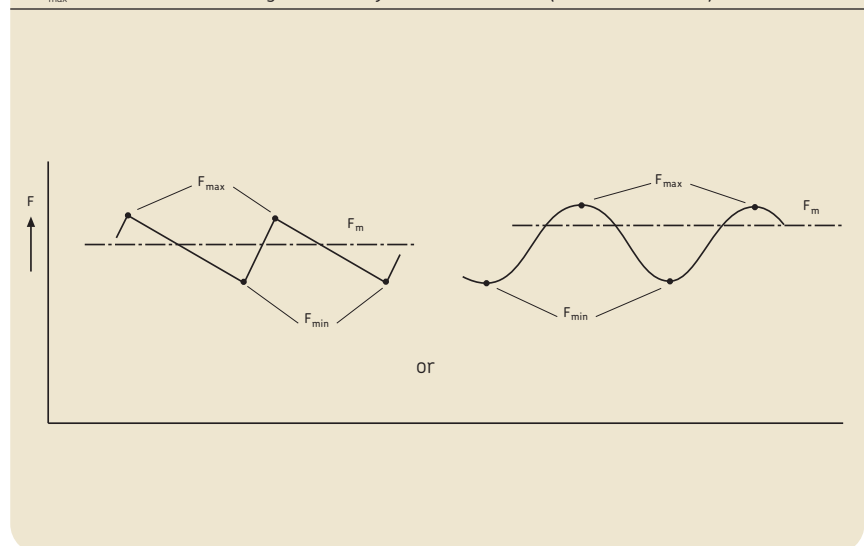

Fig 2.3: Mean load F_m at constant maximum and minimum forces (approximation) F_{max} to be used when taking static safety into consideration (see also table 2.8)



This mean load F_m of the total load cycle is equal to the equivalent dynamic load P .

As a rule, the equivalent bearing load P should not exceed 50 % of the dynamic load rating C :

$$(2.21) \quad P \leq C / 2$$

There are however load cases where the equivalent dynamic load $P = F_m$ cannot be used, especially where P is determinable only through a combination of moment loads and radial loads in a partial stroke area (e.g. during acceleration phases) while another partial stroke consists of a radial load exclusively. In such cases it is recommended to use the equation

$$(2.22) \quad s / L = s_1 / L_1 + s_2 / L_2 + \dots + s_i / L_i$$

where

- L basic rating life of the bearing
- L_i basic rating life of the bearing, assuming that the equivalent load P_i acts along the total stroke s

This equation can also be used if the bearing unit operates in unloaded condition or is stationary for limited periods. If a basic rating life L_1 has been determined under load F_1 or P_1 which acts during a time proportion of only 60 % ($q_1 = 0,6$) while the

bearing unit operates in unloaded condition or is at stationary during 40 %, the following applies ($L_2 \rightarrow \infty$):

$$(2.23) \quad 1 / L = q_1 / L_1 + q_2 / L_2$$

$$(2.24) \quad L = L_1 / q_1 = 1,67 \cdot L_1$$

Factor f_d for load conditions

The load acting on a linear guidance system is made up of external forces and internal, speed-dependent forces. Particularly during acceleration and deceleration there are often shock loads and vibration that can rarely be precisely quantified. For this reason the load acting on linear bearing units or guide carriages should be multiplied by the factor f_d to determine the equivalent dynamic load P . Values of speed-dependent factor f_d , obtained from practical experience, are given in the sections dealing with the individual product groups but can also be obtained from table 2.6.

Factor f_d will be advantageous where the speed and load F are known for a given new application. In such cases the equivalent load is calculated as follows:

$$(2.25) \quad P = f_d \cdot F$$

and the size of the linear bearing or carriage is determined with the help of the life equation.

Dynamic and static load fluctuation factors f_T and f_{T0}

Many applications are characterised by sinusoidal or time-dependent linear loads fluctuating about a mean value F_m :

$$(2.26) \quad F_m = (F_{min} + F_{max}) / 2$$

The load fluctuation factors f_T and f_{T0} are used for determining the equivalent dynamic and static loads

where

$$(2.27) \quad F_m = (F_{min} + F_{max}) / 2$$

and

$$(2.28) \quad P_0 = f_{T0} \cdot F_m$$

Instead of the total load F_m it is also possible to consider the respective partial stroke s_1 with load F_i . The values for linear ball bearings ($p = 3$) and linear roller bearings ($p = 10/3$) can be obtained from table 2.7. The last column gives an approximation value which is safe to use in most applications and is calculated as follows:

$$(2.29) \quad P = f_{T, approx} \cdot F_m = (F_{min} + 2 \cdot F_{max}) / 3$$

N.B.: Shock loads may reach very high values. Dropping a load with a

Table 2.6 Factor f_d for load conditions

Load conditions	f_d	
	from	to
Normal running without shock loads Speed < 15 m/min ⁻¹	1,0	1,2
Light shock loads Speed < 60 m/min ⁻¹	1,2	1,5
High shock loads Speed > 60 m/min ⁻¹	1,5	3,0

Table 2.7 Load fluctuation factors f_T and f_{T0} , with $f_{T0} = 2 \cdot F_{max} / (F_{max} + F_{min})$

$p =$	3	3	10 / 3	10 / 3	any others
f_{T0}	$f_{T,SIN}$	$f_{T,LIN}$	$f_{T,SIN}$	$f_{T,LIN}$	$f_{T,approx}$
1,1	1,005	1,003	1,006	1,004	1,005
1,2	1,020	1,013	1,023	1,015	1,020
1,3	1,043	1,029	1,050	1,034	1,043
1,4	1,074	1,051	1,085	1,058	1,073
1,5	1,112	1,077	1,127	1,088	1,109
1,6	1,155	1,108	1,174	1,123	1,149
1,7	1,202	1,142	1,225	1,160	1,193
1,8	1,251	1,179	1,278	1,201	1,240
1,9	1,304	1,219	1,334	1,244	1,288
2,0	1,357	1,260	1,390	1,288	1,337

force F from a height $H = 0$ will exert a force of $2 \cdot F$ on the base! A blow with a 1-kg hammer to a firm support may reach a force of up to 150 ... 200 kN, i.e. a shock factor of 10 000!

Basic static load rating C_0

The basic static load rating is the static load which corresponds to a calculated load applied through the centre of the highest loaded contact zone between shaft and rolling elements of 5 300 MPa. This stressing is expressed as the maximum Hertzian pressure which the linear rolling bearing can tolerate from experience. These values vary slightly for the different types of linear rolling bearings. The resulting total permanent deformation of rolling elements and raceway represents approximately 0,0001 of the rolling element diameter.

Static load carrying capacity

When selecting a linear rolling bearing, the basic static load rating C_0 must be considered when one of the following cases arises:

- The bearing is stationary and is loaded for long periods or is shock loaded.
- The bearing operates under load at very low speeds.
- The bearing operates normally but must also accept heavy shock loads.

In all such cases the permissible load is determined not through material fatigue but through the permanent physical deformation at the contact zone of the rolling elements and raceways. Load applied when stationary or at very low operating speeds, as well as heavy shock loads, causes flattening of the rolling elements and results in damage to the raceways. The damage may be uneven or may be spaced along the raceway at intervals corresponding to the rolling

element separation. This permanent deformation leads to vibration in the bearing, noisy running and increased friction and may even cause an increase in clearance. With continued operation this permanent deformation may become a starting point for fatigue damage due to resulting peak loads.

The seriousness of these phenomena will depend on the particular bearing application.

When determining the bearing size according to static load carrying capacity one must consider a certain relationship, known as the static safety factor s_0 between the basic static load rating C_0 and the equivalent load P_0 in order to obtain the static load rating of the bearing.

Permissible static moments $M_{0,max}$

The maximum permissible static moments given in many linear rolling bearing catalogues are usually indicated as M_x , M_y and M_z . These values correspond to a static load safety $s_0 = 1$.

For historical reasons the designations M_c , M_A and M_B instead of M_x , M_y and M_z are also used, especially where profile rail guides are concerned.

The latest bearing catalogues use more unequivocal symbols $M_{0x,max}$, $M_{0y,max}$ and $M_{0z,max}$ in order to enable the differentiation of these values from the maximum permissible dynamic moments relative to the basis $L = 100$ km.

Effective static load rating $C_{0,eff}$

The static load ratings quoted in the SKF linear bearing tables are valid for that direction of load conforming to the maximum load carrying capacity of the linear rolling bearing and where the bearing operates under optimum conditions. In order to enable deviating operating conditions to be taken into consideration in the static load safety equation, the effective

static load rating needs to be calculated by including the most important operating factors.

$$(2.30) \quad C_{0,eff} = f_{l0} \cdot f_m \cdot f_{h0} \cdot C_0$$

These factors influence the basic static load rating C_0 and may include the influence of the direction of load, misalignment, raceway hardness, number of bearings etc. Often the reciprocals are used to determine the equivalent static load P_0 for the various linear rolling bearings. This is due to convention and the different levels of standardisation.

However the effective static load rating is often replaced by the recommendation of a static load safety s_0 value adjusted to the operating conditions.

Equivalent static bearing load P_0

The equivalent static bearing load is defined as that static load which, if applied, would cause the same permanent deformation in the bearing as the actual load. This is determined by the maximum load F_{\max} , which can occur at any time.

For carriages or complete slide guides, P_0 is calculated approximately as follows:

$$(2.31) \quad P_0 = F_0 + f_{T0} \cdot (F_{0,\max} + C_{0,\text{eff}} \cdot M / M_{0,\max})$$

where

- P_0 equivalent static load, N
- F_0 preload, N
- $F_{0,\max}$ external static load, N
- f_{T0} static load fluctuation factor (table 2.7)
- $C_{0,\text{eff}}$ effective static load rating, N
- M moment generated by external static load, Nm
- $M_{0,\max}$ maximum permissible moment of the carriage or slide acting in the same direction ($M_{0x,\max}$, $M_{0y,\max}$ or $M_{0z,\max}$), Nm

For a linear rolling bearing without preload operating under vibrating load conditions follows from formula

$$(2.31a) \quad P_0 = f_{T0} \cdot F_{\max}$$

Static load safety s_0

The static load safety, expressed as the ratio between the basic static load rating and the equivalent static load, gives the degree of safety against excessive permanent deformation of the rolling elements and raceways. Depending on the operating conditions and requirements on the quietness of running, a static load safety s_0 according to table 2.8 is recommended based on experience.

Osculation φ

The osculation of a linear rolling bearing and in particular of a linear ball bearing refers to the degree of contact (not the angle of contact) of a rolling element, mostly a ball, at a right angle to the normal direction of movement. The osculation is defined as the ratio of the raceway segment radius to the ball diameter or the double radius of curvature of a rolling element in this plane and thus always represents a value greater than 0,5.

The indices i and e indicate the internal and external raceways where this is possible or required.

$$(2.32) \quad \varphi_{i,e} = r_g / D_w = r_g / (2 \cdot r_w) > 0,5$$

where

- φ osculation
- r raceway or rolling element radius, mm
- D_w ball diameter mm
- index i internal
- e external
- g relating to the raceway
- w relating to the rolling element

Life calculation

The basic rating life of a linear rolling bearing may be calculated from:

$$(2.33) \quad L_{10} = f_s \cdot (C / P)^p$$

Where the stroke length and frequency are constant it is often easier to calculate the basic rating life in hours of operation or number of double strokes using the equations:

$$(2.34) \quad L_{10h} = 5 \cdot 10^7 \cdot f_s \cdot (C / P)^p / (60 \cdot s \cdot n)$$

or

$$(2.35) \quad L_{10d} = 5 \cdot 10^7 \cdot f_s \cdot (C / P)^p / s$$

where

- L_{10} basic rating life, 10^5 m
- L_{10h} basic rating life in hours of operation
- L_{10d} basic rating life in double strokes
- C basic dynamic load rating, N
- P equivalent dynamic bearing load, N
- p life exponent:
 - linear ball bearings $p = 3$
 - linear rolling bearings $p = 10/3$
- f_s factor for the influence of stroke length (table 2.1)
- s single stroke length, mm (from one end position to the other)
- n stroke frequency, min^{-1} (number of movements from one end position to the other and back again)

Table 2.8 Recommended static safety (minimum values)

Operating conditions	s_0 from	up to
smooth, vibration-free	1	2
normal running	2	4
shock loads or vibration	3	5

Adjusted rating life

In the above life equation, consideration is given to the influence of load on the life of a given bearing. Where the bearing is used for conventional applications, this calculation of the basic rating life is adequate since, according to experience, the value of L_{10} also takes into account the influence of lubrication. However it is also appropriate to take a closer look at other factors which may influence the life of a bearing. The following equation may then be applied:

$$(2.36) L_{ns} = c_1 \cdot c_2 \cdot f_s \cdot (C_{eff}/P)^p$$

where

- L_{ns} adjusted rating life, 10^5 m
- C_{eff} effective dynamic load rating, N
- P equivalent dynamic bearing load, N
- p life exponent:
linear ball bearings $p = 3$
linear rolling bearings $p = 10/3$
- c_1 factor for reliability
(see table 2.9)
- c_2 factor for operating conditions
(see fig. 2.4)
- f_s factor for the influence of stroke length (see table 2.1)

The calculation of the adjusted rating life L_{ns} presupposes that the operating conditions are accurately defined and that the bearing load can be exactly determined, i.e. that the total load, shaft deflection etc. are taken into account in the calculation. If it is assumed that the generally accepted reliability of 90 % is adequate, that the bearings are manufactured from materials which are suitable for the given dynamic load ratings and that the operating conditions are normal, then $c_1 = c_2 = 1$. In such cases the basic rating life and the adjusted rating life are the same.

Survey of different bearing lives

- L or L_{10} basic rating life in 100 km
(aka L_s or L_{10s})
 - L_{10h} basic rating life in h
 - L_{10d} basic rating life in double strokes
 - L_{ns} adjusted rating life in 100 km
 - L_{nh} adjusted rating life in h
 - L_{nd} adjusted rating life in double strokes
- where n the percentage of failure probability = $1 - \text{reliability}$

Factor c_1 for reliability

The reliability is defined as the probability expressed as a percentage of a group of apparently identical linear rolling bearings running under identical conditions that will, according to calculation, attain or exceed a certain life. The reliability of a single linear rolling bearing is the probability that the bearing will attain or exceed a certain life. Different values for reliability are taken into consideration by using the factor c_1 from table 2.9 (see also "Adjusted rating life").

Table 2.9 Factor c_1 for reliability

Reliability %	L_{ns}	c_1
50	L_{50s}	5,04
60	L_{40s}	3,83
70	L_{30s}	2,77
80	L_{20s}	1,82
90	L_{10s}	1
95	L_{5s}	0,62
96	L_{4s}	0,53
97	L_{3s}	0,44
98	L_{2s}	0,33
99	L_{1s}	0,21

Factor c_2 for operating conditions

The factor c_2 is determined largely by the lubrication of the bearing. The efficiency of lubrication is mainly influenced by the degree of surface separation at the ball/raceway contacts. Assuming normal clean conditions for the bearing and efficient seals, the value of c_2 is governed by the viscosity ratio κ as shown in fig. 2.4. κ is defined as a ratio of the actual lubricant viscosity ν to the viscosity ν_1 required for adequate lubrication, both values being at the operating temperature. If the viscosity ratio $\kappa = \nu/\nu_1$ is less than 1, a lubricant with EP additives is recommended. If it is less than

0,4, the use of EP additives is essential.

A lubricant with EP additives may also enhance operational reliability in cases where κ is less than 1 (fig. 2.4, grid area). Of the EP additives used to date it is known that, in comparison with lubricants which do not contain such substances they can extend the bearing life in cases where no separating elastohydrodynamic film is present.

However some lubricants contain EP additives which have shown to have a detrimental effect upon bearing steels. In such cases drastically reduced values of bearing life have been recorded.

Fig. 2.4 Factor c_2 for operating conditions

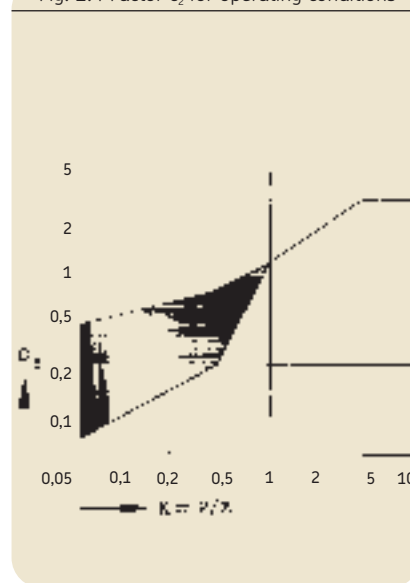
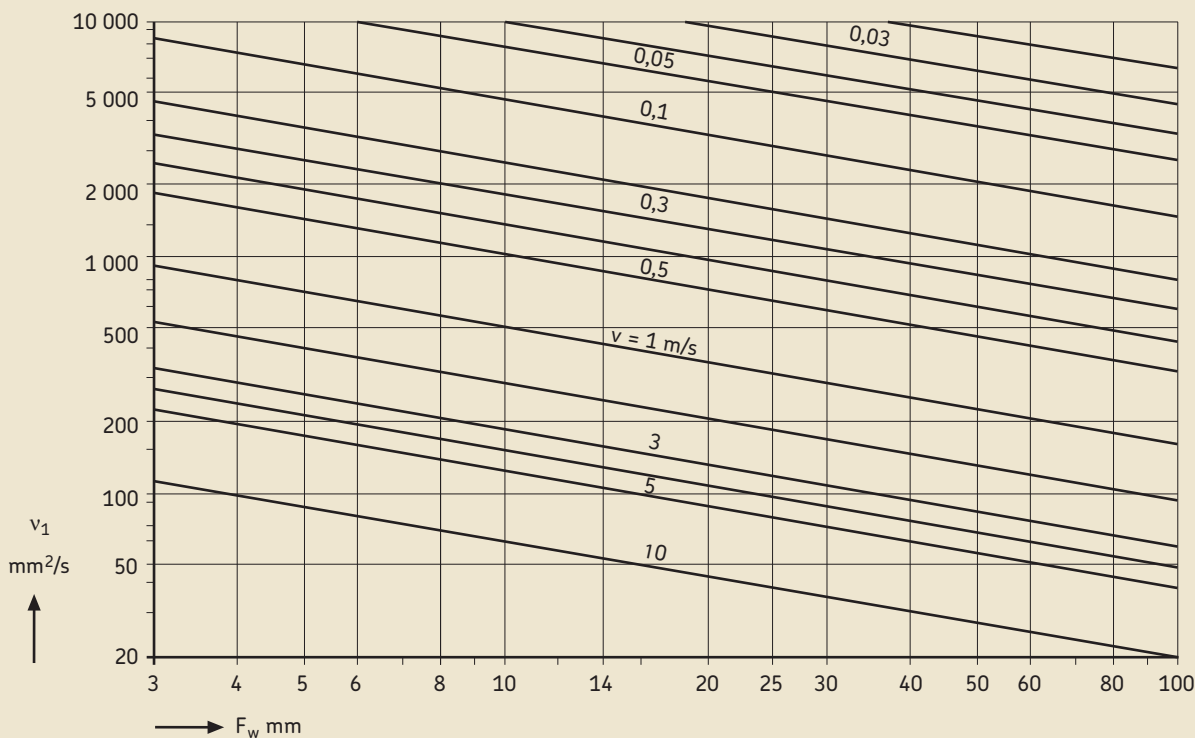

Fig. 2.5 Requisite kinematic viscosity ν_1



Greases containing EP additives should therefore be selected with the utmost care. It is recommended that the lubricant manufacturer be asked for an assurance that any incorporated EP additives will not have the effect of reducing the life of a bearing. Customers are also invited to contact SKF for advice.

The minimum kinematic viscosity v_1 in relation to the bearing size (F_w : shaft diameter) and operating speed can be obtained from fig. 2.5. The diagram is valid for mineral oils but can also be used for lubricating greases with mineral base oils. In such cases the value obtained represents the required viscosity of the base oil at the operating temperature.

Fig. 2.6 Lubricant viscosity v vs. temperature t

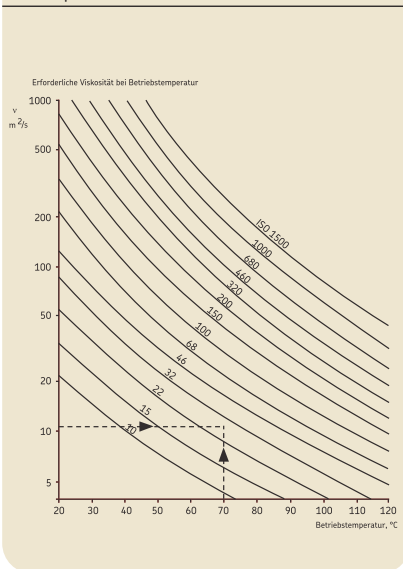

If the operating temperature is known through experience or can be determined by other means, the viscosity at the international standard temperature of 40 $^{\circ}C$ can be obtained from fig. 2.6. The curve corresponds to

$$(2.37) \quad \ln v = \ln k + (735 \dots 1600) / (120 + t)$$

with t temperature ($^{\circ}C$) and $k = 0,05$

Running accuracy of linear rolling guides

The required running accuracy is of principal importance when selecting linear guidance systems. In linear rolling guides it is determined by the manufacturing tolerance of the raceway on one hand and by the precision of the adjacent components and mounting accuracy on the other. The accuracy class and manufacturing accuracy of the mating parts should correspond to each other. Experience has shown that a higher accuracy class will not improve the running accuracy of the guidance system if the manufacturing accuracy is not correspondingly increased.

Stiffness of linear rolling guides

In addition to load carrying capacity, the stiffness, or its reciprocal elasticity, is another important aspect for selecting the most suitable linear guidance system. By definition stiffness is the ratio of load to deflection, usually measured at the point of load application and in load direction. The deflection of the individual guide elements normally results in the total deflection. Parallel and series connection of the individual elements have to be taken into consideration. The calculated or measured stiffness of the guidance system can thus be much lower than the stiffness in the rolling contact zone.

Due to the contact conditions between rolling elements and raceways, linear guidance systems with cylindrical or needle rollers offer greater stiffness than those incorporating balls.

The elastic deformation of the linear rolling bearings can often be indicated as a function of the static load rating C_0 and relate to zero-clearance guides if not stated otherwise. If radial clearance occurs for reasons of mounting, greater elastic deformation must be expected as there is a smaller number of rolling elements in contact. If necessary the radial clearance should to be included in the calculation as reverse clearance. With preloaded guides however the elastic deformation is smaller, i.e. the stiffness is higher than with zero clearance.

The overall system stiffness can be determined either by complex direct load measurements (laser systems), or with the help of vibration measurements i.e. by measuring the frequency compliance.

Permissible operating conditions

The principal operating limits must not be exceeded for the correct functioning of a linear ball bearing guidance system. The validity of the operating life calculations depends on the observance of the operating conditions described below.

Permissible maximum load

ISO 14728 stipulates that the calculation of bearing life is valid only when the equivalent dynamic loading of a linear ball bearing does not exceed 0,5 of the C rating. Any higher loading leads to erratic stress distribution which can have a negative effect on the life of the bearings.

Where such conditions exist the user should seek advice on the calculation of bearing life.

ISO 14728, part 2 specifies methods for calculating the static load ratings and static safety values of linear rolling elements.

Requisite minimum load

In order to assure slip-free running of a linear rolling bearing, the load must be kept higher than a predefined minimum value. As a general guideline, a load of $P = 0,02 C$ is acceptable. Minimum load is vital in linear guidance systems which operate at high speed or with high acceleration. In such cases the inertia forces of the rolling elements and the friction within the lubricant can have an adverse effect on the rolling conditions in the bearing and can lead to damaging slip conditions between the rolling elements and raceways.

Permissible operating temperature

The permissible operating temperature range for SKF linear rolling bearings is from -20 °C to $+80\text{ °C}$. It is dictated by the cage and seal materials and applies to continuous operation. Lower and higher temperatures can be tolerated for brief periods.

Higher temperatures are permissible for guides having metallic cages and no or heat-resistant elastic seals, provided that a suitable lubricant is used.

Permissible speed and acceleration

Permissible speed and acceleration are both largely determined by the contact forces between the rolling elements and raceways. Under normal operating conditions, in particular under minimum loads, the permissible speed is 5 m/s and the permissible acceleration is 100 m/s^2 . Higher running speeds and further acceleration are possible, depending on the bearing design, bearing size, applied load, lubricant and bearing preload.

Where the guideline values for speed and acceleration are exceeded, it is recommended that SKF be asked for advice. As a rule, specific design details are required for such linear guiding applications.

Requisite minimum stroke

Operating conditions may occur in linear rolling bearing applications and in particular those using precision rail guides, which are characterised by short stroke lengths at high frequencies. Under such conditions it will not be possible to ensure the perfect function of the bearing arrangement from the tribological point of view. Prolonged operation of the guide under such conditions will lead to increased wear in the rolling contact of the raceways that will result in tribocorrosion in the rolling element distance. As a general guideline a minimum stroke length of $s = D_w$ (rolling element diameter) should therefore be adhered to. The use of sliding guides is recommended for applications where shorter stroke lengths are required. (See also "Effective dynamic load rating C_{eff} " and "Factor for stroke length f_s ")

Stationary conditions

Damage can occur to linear rolling bearings where they may be stationary for long periods and subject to vibration from external sources.

Micro-movement in the contact zone between rolling elements and raceways can damage the surfaces. This will cause significant increase in running noise and premature failure through material fatigue. Damage of this kind through vibration when stationary should be avoided at all costs, for instance by isolating the bearings from external vibration and taking suitable precautions during transport.

Friction

Friction in a linear guidance system is affected, apart from the loading, by a number of other factors, notably the type and size of the bearing, the operating speed, as well as the quality and quantity of the lubricant used.

The cumulative running resistance of a linear rolling bearing is defined by the levels of several factors: the rolling and sliding friction at the rolling elements' contact zone, friction at the points of sliding contact between the rolling elements and cage and also friction at the guiding surfaces of the return zones. Running resistance is also governed by the extent of friction within the lubricant, and friction from the contact seals in the case of sealed bearings.

The coefficients of friction for bearings with shields (contact single- and double-lip seals) are higher due to the added friction from the seals.

In rail guides with wipers the coefficients of friction are significantly higher since the friction from the seals adds to that from the rolling contacts. In addition, higher starting friction has to be expected. The use of bellows will also result in a certain increase in friction.

For lightly loaded linear rolling bearings, the lubricant has a marked effect on the frictional properties.

Linear rolling bearings lubricated with a grease having a minimum viscosity in accordance with our recommendations, will give a correspondingly higher level of basic friction due to the shearing stresses within the grease. This effect will however be reduced to a minimum after a certain period as the grease inside bearing becomes evenly distributed and the surplus is removed from the ball return paths (running-in effect).

Lubrication

In order to function efficiently, linear rolling bearings need sufficient lubrication to prevent metallic contact between the individual rolling elements as well as between these elements and the raceways and return paths. This reduces friction and at the same time provides protection of the surfaces against corrosion.

The most favourable operating temperature for a linear rolling bearing is obtained when the minimum quantity of lubricant required to provide adequate lubrication is used. However, the quantity of lubricant to be used is also influenced by whether the lubricant has to perform additional functions such as sealing and heat dissipation.

Lubricating properties of greases and oils deteriorate with time as a result of mechanical working and ageing. It is therefore necessary to replenish or renew the used lubricant at regular intervals.

The choice of lubricant is governed by the operating conditions, such as the permissible temperatures or speeds, but may also be determined by the lubrication used for adjacent components.

Further information on general aspects of lubrication can be found in GfT work sheet 3 published by Gesellschaft für Tribologie e.V., Moers, Germany.

Grease lubrication

Under normal operating conditions, linear rolling bearings can be lubricated with grease in the majority of applications. Grease has the advantage over oil that it is more easily retained in the bearing – particularly when shafts are inclined or vertical – and it furthermore contributes to sealing the bearing against the ingress of contaminants, damp or water.

The grease should be applied before mounting by spreading it on the rolling elements which should then be turned several times. For bearings with contact seals (suffix LS or 2LS) it is also recommended that grease be applied behind the sealing lip.

Lubricating greases

Lubricating greases are thickened mineral or synthetic oils, the thickeners usually being metallic soaps. Additives can also be included to enhance certain properties of the grease. The consistency of the greases depends largely on the type and concentration of the thickener used. When selecting a grease, the viscosity of the base oil, the consistency, operating temperature range, rust inhibiting properties and the load carrying capacity are the most important factors to be considered.

Base oil viscosity

The statements regarding the importance of the oil viscosity for the formation of an oil film to separate the bearing surfaces and thus for the life of a bearing in the paragraph "Factor c_2 for operating conditions" in the general technical section are equally valid for the base oil viscosity of lubricating greases.

Commercially available greases for bearings have a base oil viscosity of between 15 and 500 mm²/s at 40 °C. Greases based on oils having

higher viscosities than this bleed oil so slowly that the bearing will not be adequately lubricated. Therefore if a very high viscosity is required because of low speeds, oil lubrication will generally be more reliable.

Consistency

Greases are divided into various consistency classes according to the National Lubricating Grease Institute (NLGI) Scale (DIN 51 818). Metallic soap-thickened greases of consistency 1, 2 or 3 are those normally used for linear ball bearings. The consistency should not vary appreciably within the normal operating temperature range and under normal operating conditions. Greases which soften at higher temperatures may, under some circumstances, leak from the bearing. Those which become very viscous at low temperatures can impair the operation of the bearing. If the linear ball bearing is subjected to frequent vibration, exceptional demands are placed on the grease. For such applications, greases with high mechanical stability should be selected.

Temperature range

The temperature range over which a grease can be used depends largely on the type of base oil and thickener used as well as the additives.

The lower temperature limit, i.e. the lowest temperature at which the grease will allow the bearing to be started up without difficulty, is largely determined by the type of base oil and its viscosity. The upper temperature limit is governed by the type of thickener and indicates the maximum temperature at which the grease will provide lubrication for a bearing. Grease will age and oxidise with increasing rapidity as the temperature increases and the by-products of oxidation have a detrimental effect on lubrication. The upper

temperature limit should not be confused with the “drop point” quoted by the lubricant manufacturers. This only indicates the temperature at which the grease loses its consistency and becomes fluid.

Table 2.10 gives the operating temperature ranges for the types of grease normally used for linear rolling bearings. These values are based on extensive testing carried out by SKF laboratories and may differ from those quoted by lubricant manufacturers. They are valid for commonly available greases having a mineral oil base and with no EP additives. Of the grease types listed, lithium and more particularly lithium 12-hydroxystearate base greases are those most used for bearing lubrication.

Greases based on synthetic oils, i.e. ester oils, synthetic hydrocarbons or silicone oils, may be used at temperatures above and below the operating temperature range of mineral oil based greases.

Protection against corrosion; behaviour in the presence of water

The rust inhibiting properties of a grease are mainly determined by the rust inhibiting additives and the thickener used.

A grease should provide protection of the bearing against corrosion and should not be washed out of the bearing in cases of water penetration, as is the case with ordinary sodium base greases. Very good resistance to water and protection against corrosion is offered by lithium and calcium base greases containing lead-based additives. However, environmental and health reasons mean that such additives are increasingly being replaced by other combinations of additives which do not always offer the same protection.

Table 2.10 Operating temperature range for lubricating greases

Grease type (Thickener)	Recommended operating temperature range (°C)	
	from	up to
Lithium base	-30	+110
Lithium complex	-20	+140
Sodium base	-30	+80
Sodium complex	-20	+140
Calcium (lime) base	-10	+60
Calcium complex	-20	+130
Barium complex	-20	+130
Aluminium complex	-30	+110
Inorganic thickeners (bentonite, silica gel, etc.)	-30	+130
Polyurea	-30	+140

Load carrying capacity

For heavily loaded linear rolling bearings it has been customary to recommend the use of greases containing EP additives, since these additives increase the load carrying capacity of the lubricant film.

Originally, most EP additives were lead-based compounds and there was evidence to suggest that these were beneficial in extending bearing life where lubrication was otherwise poor, e.g. when $k < 1$. However, for the reasons cited above, many lubricant manufacturers have replaced the lead-based additives by other compounds, some of which have been found to be aggressive to bearing steels. Drastic reductions in bearing life have been recorded in some instances.

The utmost care should therefore be taken when selecting an EP grease and an assurance should be obtained from the lubricant manufacturer that the EP additives incorporated are not of the damaging type. In cases where the grease is known to perform well a check should be made that its formulation has not been changed.

Miscibility

It is especially important to consider the miscibility of greases when, for whatever reason, it is necessary to change from one grease to another. If greases which are incompatible are mixed, the consistency can change dramatically and the maximum operating temperature of the grease mix be so low, compared with that of the original greases, that bearing damage cannot be ruled out.

Greases having the same thickener and similar base oils can generally be mixed without any detrimental consequences, e.g. a sodium base grease can be mixed with another sodium base grease. Calcium and lithium base greases are generally miscible with each other but not with sodium base greases. However, mixtures of compatible greases may have a consistency which is less than that of either of the component greases, although the lubricating properties are not necessarily impaired. In bearing arrangements where a low consistency might lead to the escape of grease from the arrangement, the next lubrication should involve complete replacement of the grease rather than replenishment. (N.B.: With excess lubrication or where pneumatic relubrication

devices are used, there is a danger that seals can become loose).

The preservative with which SKF bearings are treated is compatible with the majority of rolling bearing greases but not with polyurea greases and food compatible greases (see section "Preparation for mounting").

Lubricating greases from SKF

The SKF range of lubricating greases for rolling bearings comprises four different greases and covers virtually all application requirements. These greases, the development of which was based on the latest technology regarding rolling bearing lubrication, have been thoroughly tested both in the laboratory and in the field. Their quality is continuously monitored by SKF. The most important technical data of SKF greases are given in table 2.11. Further information can be supplied on request.

Relubrication intervals

The relubrication interval t_r corresponds to the minimum grease service life F_{10} of standard greases according to DIN 51825 and refers to a base temperature of +70 °C.

For grease lubricated linear guides, the lubrication interval depends primarily on the average running speed, the operating temperature and the grease quality. The figures quoted in fig. 2.7 in terms of operating hours are valid for a fixed installation operating under normal load and lubricated with a grease of good quality and where the temperature in the bearing does not exceed +70 °C. To calculate the accelerated ageing of grease under higher temperatures it is recommended that the intervals obtained from the diagram are halved for every 15 °C increase in bearing temperature above +70 °C. At a temperature of +100 °C, for instance, it should be reduced to one fourth of the normal value. The maximum operating temperature for the complete bearing,

i.e. the maximum permissible product temperature (seals!) or the grease should not be exceeded.

It should also be noted that the relubrication intervals can vary considerably between apparently equivalent greases. The statistical scatter is also considerable.

Table 2.11 SKF lubricating greases

Properties	SKF lubricating greases ¹⁾			Others	
	Lubricating greases (Designations)			LGFC 2 ²⁾	M.L.2 plus ³⁾
	LGMT 2	LGLT 2	LGEP 2		
Designation suffix ⁴⁾	GME	LT20	VT143 ⁵⁾	GFB	GEG
Thickener (Soap)	Li	Li	Li	Ca	Li
Base oil	Mineral oil	Diester oil	Mineral oil	Vegetable oil	Mineral oil
Temperature range, °C (continuous running)	-30 to +120	-55 to +110	-20 to +110	-20 to +80	-25 to +110
Kinematic viscosity of base oil, mm ² /s at 40 °C	110	15	200	40	310
Consistency (NLGI class)	2	2	2	2	2
Application (sliding friction and wear)	Normal temperature	Low-temperature	EP grease	Food compatible	Reduction of sliding friction and wear

¹⁾ For further technical information see "Tools for trouble-free operation"
²⁾ Molykote Longterm 2 pls, manufacturer: Dow Corning GmbH, Munich
³⁾ Not compatible with anti-corrosion agents
⁴⁾ E.g. linear ball bearings: LBCR 30-2LS/GEG
⁵⁾ as from July 2007 this suffix will cease to exist, because all ball bearings size 6 to 80 will be factory pre-lubricated with LGEP 2 as standard.

Fig. 2.7 Relubrication intervals

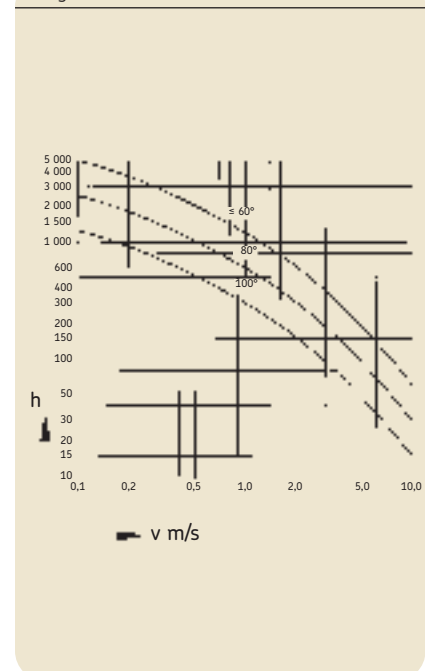

Relubrication

Rolling bearings have to be relubricated if the service life of the grease used is shorter than the expected service life of the bearing. A bearing should always be relubricated at a time when lubricating conditions are still satisfactory. Relubrication intervals depend on many inter-related, complex factors. These include bearing type and size, speed, operating temperature, grease type, space around the bearing and the bearing environment. It is only possible to base recommendations on statistical rules.

The information given in the preceding section is based on long-term tests in various applications but does not apply to those where water and/or solid contaminants can penetrate the bearing arrangement. In such cases it is recommended that the grease be more frequently replenished or renewed to remove contaminants or moisture from the bearing.

Relubrication of linear rolling bearing arrangements should be carried out in accordance with one of the following procedures, depending on the given interval:

- If the relubrication interval is shorter than 6 months, then it is recommended that the grease fill in the bearing arrangement be replenished at intervals equal to half the prescribed period. The complete grease fill should be replaced after three replenishments, at the latest.
- When lubrication intervals are longer than 6 months, it is recommended that all used grease be removed from the bearing arrangement and replaced by fresh grease.

The six-month limit represents a very rough guideline recommendation and may be adapted to fall in

line with lubrication and maintenance recommendations applying to the particular machine or plant.

Replenishment

By adding small quantities of fresh grease at regular intervals the used grease in the bearing arrangement will be only partially replaced. Suitable quantities to be added can be obtained from

$$(2.38) \quad G_p = \text{const} \cdot A_1 \cdot A_2$$

This shows that the amount of fresh grease is not measured by the available space but serves to form a lubricating film of a thickness of several tens of millimetres. For instance the following approximation formula applies to a linear ball bearing:

$$(2.38a) \quad G_p = \text{const}_1 \cdot D \cdot C$$

where

G_p	grease quantity to be added when replenishing, g
A_1, A_2	two characteristic bearing lengths, mm
D	bearing outside diameter, mm
C	overall width of linear rolling bearing, mm
const_1	0,0005 for closed 0,0003 for open design linear ball bearings

Lubrication nipple

In order to assure efficient lubrication, all SKF linear bearing units of ISO series 3, with the exception of flanged units, are provided with lubrication nipples.

Oil lubrication

Oil is generally used for rolling bearing lubrication when high speeds and/or operating temperatures preclude the use of grease, or when frictional or applied heat has to be

transferred away from the bearing position. It is also used when adjacent components are already oil-lubricated.

Lubricating oils

As a rule solvent-refined straight mineral oils are rarely suitable for the lubrication of linear rolling bearings. High-grade mineral oils containing additives to improve certain oil properties such as qualities under extreme pressure, the effect of ageing etc. are recommended.

The remarks covering EP additives in the section on greases, entitled "Load carrying capacity", also apply to EP additives in oils.

Selection of lubricating oil

The selection of an oil is primarily based on the viscosity required to provide adequate lubrication for the bearing.

The viscosity of a lubricating oil is temperature dependent. Less viscous oils are specified for higher temperature applications. The viscosity/temperature relationship of a given oil is characterised by the viscosity index V_i . The lower the variation of viscosity with temperature, the higher the viscosity index. For rolling bearing lubrication, oils having a viscosity index greater than 85 are recommended.

In order for a sufficiently thick film of oil to be formed in the contact area between rolling elements and raceways, the oil must retain a certain minimum viscosity at the operating temperature. The kinematic viscosity v_1 required at the operating temperature to ensure adequate lubrication can be determined from the diagram in fig. 2.5. When the operating temperature is known from experience or can otherwise be determined, the corresponding viscosity at the internationally standardised reference tem-

perature of 40 °C can be obtained from the diagram in fig. 2.6.

When selecting the oil the following aspects should be considered:

- Bearing life may be extended by selecting an oil whose viscosity ν at the operating temperature is somewhat higher than ν_1 . However, since increased viscosity raises the bearing operating temperature there is frequently a practical limit to the degree of improvement achievable here.
- If the viscosity ratio $\kappa = \nu/\nu_1$ is less than 1, an oil containing EP additives is recommended and if κ is less than 0,4, the use of an oil with such additives is mandatory. (See also "Factor c_2 for operating conditions")
- For exceptionally low or high speeds, critical loading conditions or for unusual lubricating conditions please consult SKF.

Mounting

Great care and attention to cleanliness are essential when mounting SKF linear bearings, to obtain optimum performance and to avoid premature bearing failure. SKF linear rolling bearings are precision products and should be handled appropriately. Above all, the correct installation procedures should be followed and the appropriate tools used at all times. In particular, we refer you to the SKF brochure "Tools for trouble-free operation".

Preparation for mounting

Mounting should be carried out in a dry, dust-free room away from metalworking or other machines producing swarf or dust.

Before mounting the bearings, all the necessary parts, tools and equipment should be at hand. All parts of the linear guide (housing, shaft, etc.) should be carefully cleaned and deburred if necessary and the accuracy of form and dimensions checked against the specification. The bearings will only perform satisfactorily if the prescribed tolerances are adhered to.

The bearings should not be removed from their original packaging until immediately before mounting, in order to avoid contamination. Normally the preservative with which new bearings are coated before leaving the factory should not be removed and it is necessary only to wipe it off the outer surface. Where special greases are used (e.g. a polyurea grease) which are not compatible with the preservative, the bearing must be carefully washed and dried in order to avoid any detrimental effect on the lubricating properties of the grease. The bearing must also be washed if it they became dirty due to inappropriate handling (damaged packaging etc.).

Depending on the screw quality, the screw tightening torques must be observed, provided that no lower torques are specified for the various product groups. These may be necessary due to lower screw depths, reduced contact pressure at the screw head and nut or reduced deformation at the mating parts.

Storage of linear bearings

SKF bearings are normally coated with a rust inhibiting preservative before packing and can therefore be stored for up to five years in their original unbroken packaging, provided that the relative humidity of the storage area does not exceed 60 %. Bearings with shields or seals, when stored for longer periods, may be found to have a higher initial starting torque than new bearings. It cannot be ruled out that the lubricating properties of the grease inside the bearing deteriorate with a longer time of storage.

Cleaning of linear bearings

The following procedure should be adopted for bearings which require cleaning because of contamination or the need for a grease change:

All parts should be thoroughly washed, using a suitable cleaning solvent (paraffin or acid-free white spirit, alkaline cleaning agents). Care should be taken to ensure complete removal of the layer of lubricant thickener. After cleaning, the bearing should be thoroughly dried and immediately oiled or regreased as a protection against corrosion. This is particularly important in the case of machines that are to be left stationary for long periods.

Sealing

The seals of linear rolling guides have the function to prevent the ingress of solid contamination and moisture and retain the lubricant in the guide. Even under the most unfavourable operating conditions their efficiency should be ensured at all time at a minimum of friction and wear so that the neither the bearing function nor the life of the guide is impaired.

In most applications wipers are sufficient for protecting the raceways. It must be ensured however that the wipers are in contact with the raceways along the entire stroke length. If solid contamination may penetrate through the lateral gap between the rails, it is recommended that an additional cover be used.

To prevent the contamination of the rails through environmental influences it is generally recommended that the entire linear guide including any existing drive elements such as ball or roller screws be protected with one bellow cover or if necessitated by the operating conditions, with a telescopic steel cover.

Linear ball bearings

For general technical information on linear ball bearings please see “Basic technical principles”.

Linear ball bearings are linear bearings for unlimited backwards and forwards linear movement during which the balls are constantly returned to the loaded zone in closed circuits. The bearings enable accurate linear guides to be designed simply and economically. The requisite linear ball bearing for a given linear guidance application is selected on the basis of its load carrying capacity in relation to the load being applied and the requirements in terms of service life and operational reliability.

SKF linear ball bearings are available in two size ranges and various types and designs. The range is determined according to market requirements and covers the majority of known existing applications.

Bearing types

LBBR linear ball bearings

LBBR linear ball bearings conform to the ISO Series 1 standard size range and have an extremely compact cross section. The bearing comprises a plastic cage carrying symmetrically arranged raceway segments and high-grade balls conforming to ISO 3290-1975. The LBBR raceway segment profile ensures high load bearing capacity with a resulting long service life and low noise operation.

The plastic cage has been entirely redesigned and optimised. The key feature is that all the ball circuits in the bearing are designed to allow ball recirculation to take place smoothly with no resulting cage loads. In addition, the ball diameter can be maximised with this cage design with implications not only for

load capacity and life but also for running quality. As with all modern-design linear ball bearings, the cage is made of a high-grade synthetic material. This offers high strength as well as dimensional and form stability even at elevated temperatures and outstanding resistance against most organic substances, e.g. oils, greases, fuels, bases and weak acids.

Sealed LBBR linear ball bearings are fitted with integral double lip seals. These seals have an inner lip that prevents the escape of lubricant from within the bearing and an external lip to prevent ingress of contamination. This permits long relubrication intervals, i.e. the bearings require little maintenance and are thus especially user-friendly owing to their long service life.

Unsealed bearings form a narrow gap relative to the shaft at their side



faces, thus protecting against large particle contamination.

LBBR bearings are largely self-retaining in the housing and normally need not be secured axially in the housing bore provided they are mounted in the bore with an interference fit.

Stainless

In applications which require a certain protection against corrosion, the use of LBBR linear ball bearings with raceway segments and balls of high-alloy stainless steel is recommended. These bearings are specified by the designation suffix HV6, e.g. LBBR 16-2LS/HV6. In combination with stainless steel shafts (stainless or hard chromium plated), the LBBR linear ball bearing thus offers the possibility of realising a design completely made of stainless steel.

LBCR and LBCD linear ball bearings - closed design

LBCR and LBCD linear ball bearings conform to the ISO Series 3 standard size range. They are available for shaft diameters ranging from 5 to 80 mm (LBCR) and from 12 to 50 mm (LBCD) and offer high load carrying capacity owing to asymmetrical disposition of the ball circuits (from size 12 up) and profiled raceway segments.

LBCR linear ball bearings comprise a cage which guides the balls and retains the raceway segments and seals or shields.

The cage is made of a high-grade synthetic material while the contact seals consist of heavy-duty elastomer. Bearing steel is used for the profiled raceways which are hardened and ground. They have very narrow sectional height tolerances and because of the machined raceway profile they are able to accom-

modate heavy loads. The balls comply with ISO 3290-1975.

LBCR and LBCD linear ball bearings can be mounted in closed as well as slotted housings. When mounted in a closed housing the absolute dimension of the inscribed diameter of the ball set F_w and thus the bearing operational clearance is determined by the housing bore. When mounted in a slotted housing the linear guides can be adapted to the particular application to have either operational clearance or preload.

LBCR linear ball bearings are provided with longitudinal ground raceway segments, resulting in a rigid shaft guide. LBCD bearings, on the other hand, have raceway segments with a convex spherical outer surface at the centre of the sleeve circumference, enabling an angular adjustment of ± 30 minutes of arc.

LBCT, LBHT and LBCF linear ball bearings – open design

The open LBCT, LBHT and LBCF linear ball bearings differ from the LBCR and LBCD bearings in that a sector has been cut away from the cage and the seals; as a rule a complete ball circuit. Depending on the application, this allows the shaft to be supported at several positions or along its whole length, so that the accuracy of guidance cannot be affected by any shaft deflection.

LBHT linear ball bearings, like the LBCT variety are provided with longitudinal ground raceway segments. By virtue of the increased number of raceway segments of the LBHT, this may be considered as a heavy-duty version of the LBCT. LBCF linear ball bearings, like the LBCD version, comprise alignable raceway segments.

Basic technical principles

ISO 14728, Part 1 specifies methods for calculating the dynamic and static load ratings of linear ball bearings in the majority of cases. The load bearing components of the bearing arrangement – cylindrical shaft, raceways and balls of the linear ball bearing – are manufactured using well-proven techniques, from high-quality hardened bearing steel. The raceway segments in a linear ball bearing offer optimally close osculation while the guidance element takes the form of a cylindrical shaft without grooves.

This standard also establishes methods for calculating the basic rating life. With a 90 % degree of certainty based on practical experience, this is normally achievable with today's manufacturing materials, normal product quality and normal operating conditions.

Definitions

(see also "Basic technical principles for linear rolling bearings")

Load ratings

The basic dynamic load rating C is used for the life calculation of linear ball bearings running under load. This gives the bearing load which, according to the ISO definition, results in a bearing life of 100 000 m. This is valid on the assumption that the load is constant in magnitude and direction and that it acts along the line shown in fig. 3.2, which for:

- bearings of the LBBR and LBCR design, sizes 5 and 8, runs through a load bearing row of balls.
- bearings of the LBCR and LBCD design, runs in the load direction indicated on the rear side of the cage.
- bearings of the LBCT, LBCF and LBHT design, is at right angles to the aperture.

The basic static load rating C_0 is the static load which corresponds to a calculated load applied through the ball contact zone between shaft and

ball of 5 300 MPa (Hertzian pressure). The resulting total permanent deformation of the rolling element and raceways represents approximately 0,0001 of the rolling element diameter.

The basic static load rating C_0 is to be taken into account when the bearings are loaded when stationary or at very low speed. It is also valid when the bearings are subjected to heavy impact during dynamic running conditions.

In contrast to the LBCR, LBCT and LBHT linear ball bearings which have a rigid raceway segment support along the entire length of the raceway and, in parallel axis installations, allow an even distribution of the load in longitudinal direction, the spring effect of the raceway segments and the associated uneven load distribution must be taken into consideration in the case of the LBCD and LBCF varieties. As illustrated in fig. 3.3, the ball loading of the two linear ball bearing designs is

Fig. 3.2

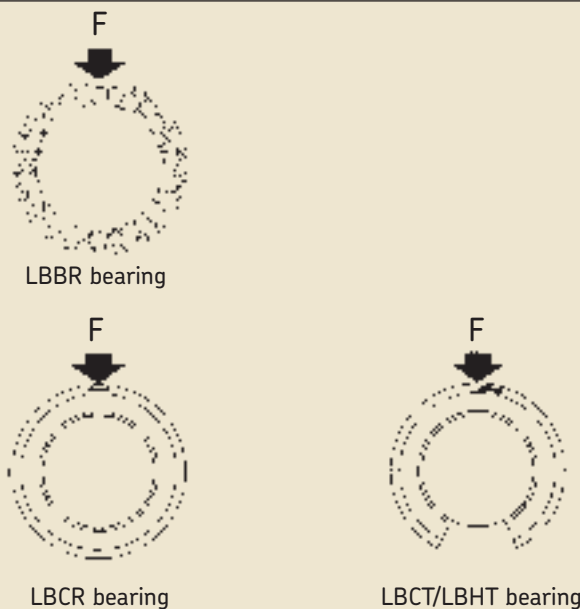
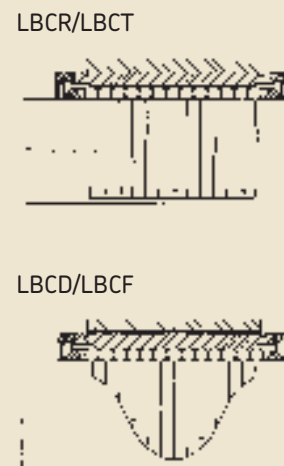

Fig. 3.3 Load distribution along the running plate



only the same in the central zone. With self-aligning ball bearings the ball loads at the raceway ends are markedly reduced due to the deflection of the raceway segments under load, which means a reduction in the load ratings or an increase in the equivalent bearing load. The failure probability of the less heavily loaded balls shows, however, that the reduction in the dynamic load rating compared with a bearing with a rigid support is not of great significance.

Osculation φ

The osculation of a linear ball bearing is defined as the ratio of the raceway segment radius to the ball diameter and represents an optimum compromise between load carrying capacity, heat generation and smooth running. As a function of the ball diameter it becomes closer with larger bearings. A close osculation however contributes little to load carrying capacity as the osculation to the shaft has a significant effect on both load ratings.

Life

The life of a linear ball bearing is taken as the distance travelled (or the number of hours of operation at constant stroke length and frequency) by the bearing before the first sign of material fatigue (spalling, pits) appears on the raceway or rolling elements.

While the basic rating life only takes into account the effect of the load applied achieved or exceeded by 90 % of the bearings with adequate lubrication, the adjusted rating life also considers other probabilities of failure and the influence of lubrication.

The calculation of the adjusted rating life L_{ns} presupposes that the operating conditions are accurately defined and that the bearing load

can thus be exactly determined, i.e. that the total load, shaft deflection etc. are taken into account in the calculation. If it is assumed that the generally accepted reliability of 90 % is adequate, that the bearings are manufactured from materials which are suitable for the given dynamic load ratings and that the operating conditions are normal, then $c_1 = c_2 = 1$. In such cases the basic rating life and the adjusted rating life are identical.

For further information see the preceding chapter "Basic technical principles for linear rolling bearings".

Life calculation

The basic rating life of linear ball bearings may be calculated from the equation:

$$(3.1) \quad L_{10} = f_s \cdot (C / P)^3$$

Where the stroke length and frequency are constant it is often easier to calculate the basic rating life in hours of operation or numbers of double strokes using the equations:

$$(3.2) \quad L_{10h} = 5E+07 \cdot f_s \cdot (C / P)^3 / (s \cdot n \cdot 60)$$

$$(3.3) \quad L_{10d} = 5E+07 \cdot f_s \cdot (C / P)^3 / s$$

The adjusted rating life may be calculated from:

$$(3.4) \quad L_{ns} = c_1 \cdot c_2 \cdot f_s \cdot (C_{eff} / P)^3$$

where

$$(3.5) \quad C_{eff} = f_h \cdot f_i \cdot C$$

This equation can also be extended correspondingly if the values for constant stroke length and frequency are known.

where

- L_{10} basic rating life, 10^5 m (failure probability 10 %)
- L_{10h} basic rating life in hours of operation
- L_{10d} basic rating life in double strokes
- L_{10ns} adjusted rating life, 10^5 m
- C basic dynamic load rating, see tables of SKF linear ball bearing catalogue, N
- C_{eff} effective dynamic load rating, N
- P equivalent dynamic bearing load, N
- c_1 factor for reliability, see table 2.9 "Basic technical principles"
- c_2 factor for operating conditions see fig. 2.4 "Basic technical principles"
- f_s factor for stroke length, see table 2.1 "Basic technical principles"
- s stroke length, mm
- n stroke frequency, min^{-1} (number of movements from one end position to the other and back again)
- f_h factor for surface hardness of shaft
- f_i factor for the number of loaded bearings per unit

Influence of raceway hardness (factor f_h)

Like the raceways of linear ball bearings, steel shafts for linear guidance systems should be hardened and ground. The surface hardness should be at least 58 HRC and the surface roughness R_a to EN ISO 4248 should never exceed 0,32 mm. If shafts with a lower surface hardness are used, the factor f_h obtained from equation 2.7 should be taken into consideration.

Lower surface hardness also influences the basic static load rating C_0 . Values shown in the catalogue should be corrected using the factor f_{ho} to equation (2.8).

Shaft material Cf53(1.1213), an unalloyed high-grade steel which is often used, $f_h=1$ (> 60 HRC) and

$f_{h0}=1$; for shafts made from stainless steel X90CrMoV18 $f_h=0.8$ (< 60 HRC) and $f_{h0}=0.95$ are chosen.

Equivalent dynamic bearing load P

If the load F acting on the linear ball bearings corresponds to the requirements for the basic load rating C , then $P = F$ and the load can be inserted directly into the life equation.

In all other cases it is necessary to calculate the equivalent dynamic bearing load. This is defined as that hypothetical load which will have the same effect, if applied, as the actual loads to which the bearing is subjected under the given conditions.

If the load is made up of a number of forces which are of constant magnitude for a given stroke length, or if a fluctuating load can be approximately resolved into a number of constant single forces (1), then the mean load can be determined approximately using

$$(3.6) \quad F_m = [(F_1^3 \cdot s_1 + F_2^3 \cdot s_2 + \dots) / s]^{1/3}$$

where

F_m constant mean load, N
 F_1, F_2 constant loads during stroke lengths s_1, s_2, \dots , N
 s total stroke length ($s = s_1 + s_2 + \dots$) during which the loads F_1, F_2, \dots act, mm

If the stroke frequency is constant and the load is constant in direction but consistently fluctuates between a minimum value F_{min} and a maximum value F_{max} (see fig. 2.3), the approximate mean load can be obtained from

$$(3.7) \quad F_m = (F_{min} + 2 \cdot F_{max}) / 3$$

This mean load F_m of the total load cycle is equated with the equivalent dynamic load P , multiplied by factors

for the direction of load f_i and misalignment f_m .

$$(3.8) \quad P = \frac{F_m}{f_i \cdot f_m}$$

Influence of direction of load, factors f_i and f_{i0}

Linear ball bearings of the LBCR and LBCD design must be mounted so that the line of action of the load falls within the sector which is marked on the end of the cage. This is generally ensured in the case of a bearing mounted in a unit and retained in position by the relubrication nipple which also acts as a stop to prevent rotation of the bearings. If the direction of the load deviates from the optimum, the load ratings must be corrected using the factors f_i or f_{i0} . This also applies to the open linear ball bearings of the LBCT, LBCF and LBHT designs if the line of action of the load deviates from the one assumed for the load ratings. The factors f_i and f_{i0} can be obtained from

- Fig. 3.4 for LBCR and LBCD linear ball bearings
- Fig. 3.5 for LBCT and LBCF linear ball bearings
- Fig. 3.6 for LBHT linear ball bearings

It is seldom possible to install LBBR design linear ball bearings so that the position of the ball rows to the actual direction of the load is accurately defined. It is therefore important for safety reasons, to use an effective dynamic load rating which is valid for the most unfavourable load case. As shown in table 3.1, this is load case A, where the line of action of the load passes through a load-bearing ball row. Only in cases where it is possible to ensure that the line of action of the load will be between two rows of balls can the higher f_i values

be used. Intermediate values to those quoted in table 3.1 are of no practical importance. An interpolation is therefore not normally needed.

Fig. 3.4 Factor f_i and f_{i0} influence of the direction of load for LBCR and LBCD linear ball bearings

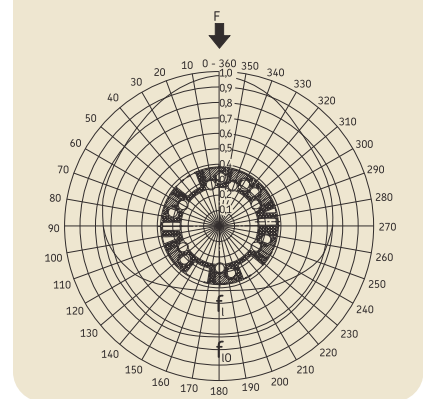

Fig. 3.5 Factor f_i and f_{i0} influence of the direction of load for LBCT and LBCF linear ball bearings

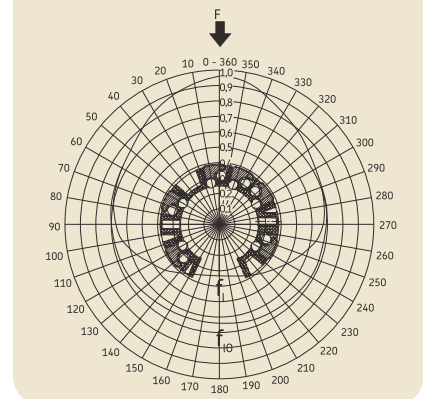
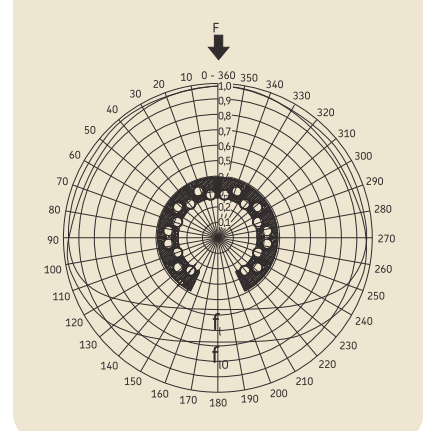

Fig. 3.6 Factors f_i and f_{i0} influence of the direction of load for LBHT linear ball bearings



Influence of misalignment (factor f_m)

Where linear guides have no support for the guide shaft, shaft deflection may occur which can cause misalignment of the shaft in the bearing with respect to the bearing axis. Such misalignment causes an uneven distribution of load within non-self-aligning linear ball bearings, which must be taken into account using the factor f_m . The inclination of the shaft in the centre of the bearing caused by the load can be calculated using the accepted equation (fig. 3.7) for the deflection of a straight rod.

Shaft misalignments relative to the bearing axis of up to ± 5 minutes of arc do not influence the dynamic load rating of these bearings. Greater misalignments must be considered and appropriate values of the factor f_m can be obtained using the approximation formula 3.9 (in minutes of arc):

$$(3.9) \quad f_m = 1,04 + \alpha \cdot (0,006 - 0,0028 \cdot \alpha)$$

For linear ball bearings of the LBBR, LBCR, LBCT and LBHT designs, misalignments greater than 15 minutes of arc are not permissible. Where larger degrees of misalignment occur due to mounting inaccuracies or appreciable shaft deflection, the use of self-aligning linear ball bearings of the LBCD or LBCF design is recommended. These allow an angular adjustment of ± 30 minutes of arc without affecting the dynamic load rating. Greater degrees of misalignment are not permissible with these designs either.

Static load carrying capacity and equivalent static load

When selecting a linear ball bearing, the basic static load rating C_0 must be considered when one of the following cases arises:

- The bearing is stationary and is loaded for long periods or is shock loaded
- The bearing operates under load at very low speed
- The bearing operates normally but must also accommodate heavy shock loads.

The maximum load F_0 acting on a linear ball bearing under a given operating condition (stationary, moving, peak vibration loads) is considered as the equivalent static load P_0 .

Table 3.0: Influence of misalignment

α (')	f_m
5,0	1,00
7,5	0,93
10,0	0,82
12,5	0,68
15,0	0,50

Table 3.1 Dynamic and static factors for the direction of load for LBBR linear ball bearings under loads acting in the y/z plane between two load-carrying ball rows. For a load direction through the ball row $f_i = f_{i0} = 1$. Intermediate positions can be interpolated linearly.

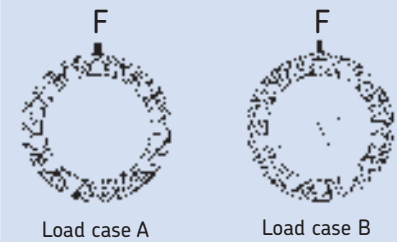

Type	f_i	f_{i0}
LBCR 5...8	1,15	1,43
LBBR 3...8	1,16	1,43
LBBR 10...16	1,19	1,47
LBBR 20	1,06	1,28
LBBR 25	0,98	1,15
LBBR 30...40	0,99	1,11
LBBR 50	1,01	1,1

Requisite basic static load rating and verification of static load carrying capacity

The requisite basic static load rating C_0 can be obtained from

$$(3.10) \quad C_0 = (s_0 \cdot P_0) / (f_{h0} \cdot f_{l0})$$

When selecting dynamically loaded linear ball bearings according to their required operating life, and where the equivalent static load P_0 is known, the static safety factor should then be checked using the formula below to ensure that the static load carrying capacity is also sufficient.

$$(3.11) \quad s_0 = \frac{f_{l0} \cdot f_m \cdot f_{h0} \cdot C_0}{P_0}$$

If the resultant value of s_0 is lower than recommended, a bearing with a higher static load rating should be selected.

where

C_0	requisite basic static load rating, N
P_0	equivalent static load, N
s_0	static safety factor
f_{h0}	factor for surface hardness of shaft, see formula (2.8)
f_{l0}	factor for direction of load
f_m	factor for misalignment

Experience shows that the value of the static safety factor s_0 for linear ball bearings depends on the mode and smoothness of operation:

For smooth, vibration-free operation:

$$s_0 = 2$$

Where heavy shock loads occur:

$$s_0 = 4$$

Stiffness of linear ball bearing guides

Next to its load carrying capacity, the stiffness of a linear guidance system is one of the most significant criteria for the selection of a suitable system. Stiffness is defined as the ratio between load and deflection at the point of application of load and in the direction of load. The deflection of the individual elements normally makes up the total deflection; parallel and series connection of the individual elements should be taken into consideration.

Because of the unfavourable contact conditions between the shaft and balls, the linear ball bearing guide possesses the least stiffness of the various linear guidance systems. Furthermore in the case of unsupported guides, the deflection of the shaft under load detracts to a significant extent from the stiffness of the system.

In order to distinguish between the various elastic deformations, they are shown for the various linear ball bearing designs including the calculation formulae for the shaft deflection in the diagrams in figures 3.7 and 3.8 to 3.10.

The elastic deformations of the linear ball bearings are quoted depending on the basic static load rating C_0 and are related to a clearance-free guide. If radial clearance occurs for mounting reasons higher elastic deformation has to be expected. It may also be necessary to insert the radial clearance as reverse clearance in the calculation. With preloaded guides the elastic deformations will be smaller, i.e. stiffness is higher than that given in the diagrams.

For an approximate determination of shaft deflection and shaft mis-

alignment with respect to the central linear ball bearing, the calculation formulae shown in fig. 3.7 should be used. Here it is assumed that a solid shaft is used and the least favourable load conditions exist, i.e. that the linear bearing unit is situated at the centre position between the shaft blocks. Bending of the shaft due to its own weight must also be taken into account. It is also assumed that the shaft is clamped at both ends. In this way a maximum value for the expected stiffness is obtained.

Fig. 3.7 Deflection and misalignment of freely supported and clamped steel shafts. Calculated using $E = 206\,000\text{ N/mm}^2$ and $r = 77\,000\text{ N/m}^3$

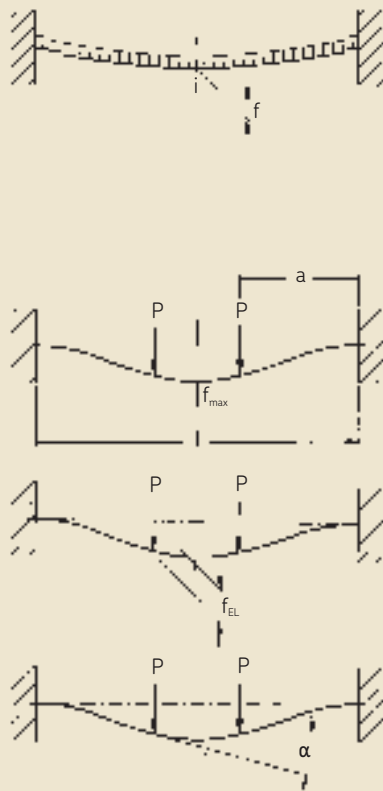

Deflection and misalignment of a hollow shaft

a) under its own weight: at the loading points f_{EG} and f_{FG} , in the middle of the shaft f_{max}

Clamped shaft:

$$f_{EG} = 2,49 \cdot 10^{-7} \cdot [a \cdot (l - a)]^2 / (D^2 - d^2)$$

$$f_{max,EG} = 1,56 \cdot 10^{-8} \cdot l^4 / (D^2 - d^2)$$

$$\alpha_{EG} = 1,71 \cdot 10^{-6} \cdot a \cdot (l^2 + 2a^2 - 3al) / (D^2 - d^2)$$

Freely supported shaft:

$$f_{FG} = 2,49 \cdot 10^{-7} \cdot a \cdot (l - a) \cdot (l^2 - a^2 + al) / (D^2 - d^2)$$

$$f_{max,FG} = 7,78 \cdot 10^{-8} \cdot l^4 / (D^2 - d^2) = 5 \cdot f_{max,EG}$$

$$\alpha_{FG} = 8,57 \cdot 10^{-7} \cdot (l^3 + 4a^3 - 6a^2l) / (D^2 - d^2)$$

b) under 2 symmetrical individual loads P' : at the loading points f_{EL} and f_{FL} , in the middle of the shaft f_{max}

Clamped shaft:

$$f_{EL} = 0,0165 \cdot P' \cdot a^3 \cdot (2 - 3a/l) / (D^4 - d^4)$$

$$f_{max,EL} = 0,00412 \cdot P' \cdot a^2 \cdot (3l - 4a) / (D^4 - d^4)$$

$$\alpha_{EL} = 0,17 \cdot P' \cdot a^2 \cdot (1 - 2a/l) / (D^4 - d^4)$$

Freely supported shaft:

$$f_{FL} = 0,0165 \cdot P' \cdot a^2 \cdot (3l - 4a) / (D^4 - d^4)$$

$$f_{max,FL} = 0,00412 \cdot P' \cdot a \cdot (3l^2 - 4a^2) / (D^4 - d^4)$$

$$\alpha_{FL} = 0,17 \cdot P' \cdot a \cdot (l - 2a) / (D^4 - d^4)$$

In fig. 3.7

- f shaft deflection, μm
- α misalignment, minutes of arc ($'$)
- P load, N
- l shaft length, mm
- D shaft diameter, mm
- d inner diameter of hollow shaft
- a distance between clamping and point of application of load, mm

Calculation example

A quadro linear bearing unit LQCD 20-2LS consisting of 4 linear ball bearings LBCR 20-2LS with closed housing is to support a load of 400 N which is constant in magnitude and direction and which acts vertically and centrally whilst operating at a stroke frequency of 30 min^{-1} and a stroke length of 600 mm. The surface hardness of the shaft is 55 HRC. The solid shaft is secured in two tandem shaft blocks. The shaft length between the two tandem shaft blocks is 1 000 mm. The linear ball bearings are lubricated with SKF grease LGEP 2 which has a base oil viscosity of $200\text{ mm}^2/\text{s}$ at $40\text{ }^\circ\text{C}$. The maximum operating temperature is assumed to be $40\text{ }^\circ\text{C}$.

What are the values of the adjusted rating life, static load safety and system stiffness?

The effective dynamic load rating can be obtained from formula

$$(3.5) \quad C_{eff} = f_h \cdot f_i \cdot C$$

where

f_h factor for surface hardness of shaft. For 55 HRC, according to formula 2.7, $f_h = 0,735$.

f_i factor for the number of loaded bearings per unit factor f_i has already been taken into consideration in the dynamic load ratings quoted for SKF linear bearing units, therefore $f_i = 1$

Thus the value for the effective dynamic load rating

$$C_{\text{eff}} = 0,735 \cdot 1 \cdot 5\,200$$

$$C_{\text{eff}} = 3\,822 \text{ N}$$

In order to calculate the equivalent dynamic load

$$P = f_i \cdot f_m \cdot F_m$$

first it is necessary to determine the values of the individual factors.

- Factor for load direction $f_i = 1$, since the line of load acts through the zone of maximum load carrying capacity of the linear ball bearing.
- Factor for misalignment $f_m = 1$ (equation 3.9), since self-aligning linear ball bearings are used in this linear unit. In spite of this, the calculation of misalignment is to be demonstrated here. The angle for the deflection of the shaft can be obtained using the general strength of materials theory (fig. 3.7). According to fig. 3.7, for a beam (shaft) which is fixed at both ends, under its own weight and with two symmetrical loads at distance $b = l - 2a$:

where

$$f_m = F / 4 = 400 \text{ N} / 4 = 100 \text{ N, load per linear ball bearing LBCR 20-2LS (centre point of the quadro linear bearing unit)}$$

$$a = 457,5 \text{ mm, distance between fixed end and middle of first linear ball bearing: } a = (L - b) / 2$$

$$d = 20 \text{ mm, shaft diameter}$$

$$l = 1\,000 \text{ mm, shaft length between fixed ends}$$

$$\alpha_{\text{ges}} = \alpha_{\text{EG}} + \alpha_{\text{EL}}$$

$$= 1,71 \cdot 10^{-6} \cdot a \cdot (l^2 + 2a^2 - 3al) / D^2 +$$

$$0,17 \cdot F_m \cdot a^2 \cdot (1 - 2a / l) / D^4$$

$$= 1,71 \cdot 10^{-6} \cdot 457,5 \cdot (1\,000^2 + 2 \cdot 457,5^2 - 3 \cdot 457,5 \cdot 1\,000) / 20^2 +$$

$$0,17 \cdot 100 \cdot 457,5^2 \cdot (1 - 2 \cdot 457,5 / 1000) / 20^4$$

$$= 0,09 + 1,89$$

$$= 1,98' \text{ (minutes of arc)}$$

Fig. 3.8 Elastic deformation of clearance-free linear ball bearings in the ball contact zone

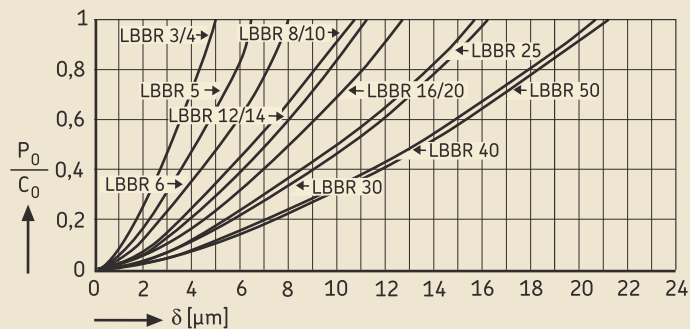

Fig. 3.9 Elastic deformation of clearance-free linear ball bearings in the ball contact zone

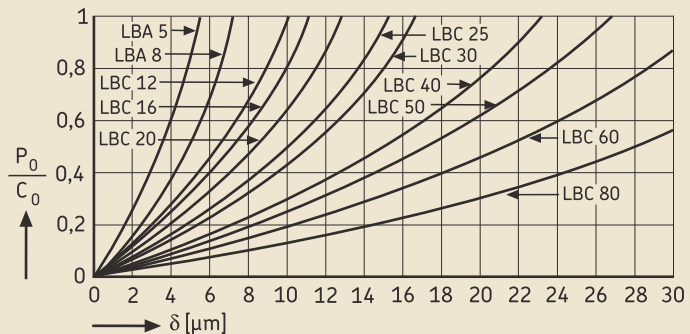
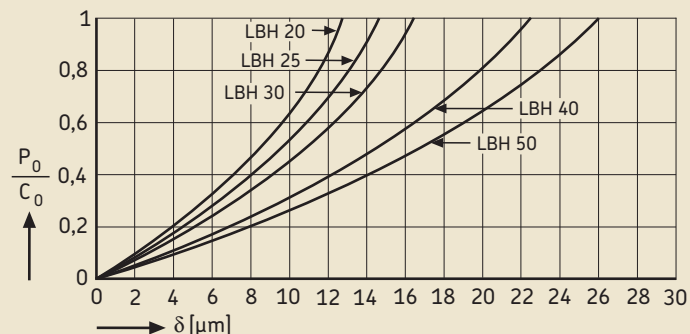

Fig. 3.10 Elastic deformation of clearance-free linear ball bearings in the ball contact zone



Assuming the same loads for a beam, freely supported at both ends:

$$\begin{aligned}\alpha_{ges} &= \alpha_{FG} + \alpha_{FL} \\ &= 8,57 \cdot 10^{-7} \cdot (l^3 + 4a^3 - 6a^2l) / D^2 + \\ &\quad 0,17 \cdot F_m \cdot a \cdot (l - 2a) / D^4 \\ &= 8,56 \cdot 10^{-7} \cdot (1\,000^3 + 4 \cdot 457,5^3 - \\ &\quad 6 \cdot 457,5^2 \cdot 1\,000) / 20^2 + 0,17 \cdot \\ &\quad 100 \cdot 457,5 \cdot (1\,000 - 2 \cdot 457,5) \\ &\quad / 20^4 \\ &= 0,27 + 4,13 \\ &= 4\,400\end{aligned}$$

(more than twice the value determined in the first calculation!)

Even for a freely supported shaft the misalignment under its own weight and the applied load is below the limit value of 5' for non-self-aligning linear ball bearings. Therefore the equivalent dynamic load of the quadro unit:

$$P = 1 \cdot 1 \cdot 400 = 400 \text{ N}$$

Thus the adjusted rating life can be obtained from:

$$L_{nh} = c_1 \cdot c_2 \cdot 5 \cdot 10^7 \cdot f_s \cdot (C_{eff} / P)^3 / (s \cdot n \cdot 60)$$

– Factor c_1 for reliability: Since no specific reliability was called for, table 2.9 may be used for a life achieved or exceeded by 90 % of the bearings:

$$c_1 = 1$$

– Factor c_2 for operating conditions: From the stroke length and number of strokes per minute, the mean velocity is

$$\begin{aligned}v &= 2 \cdot s \cdot n / 60 = 2 \cdot 600 \cdot 30 / 60 \\ &= 600 \text{ mm/s} = 0,6 \text{ m/s}\end{aligned}$$

Using the diagram in fig. 2.5 for the determination of the minimum viscosity for a linear ball bearing of size 20 operating at a mean velocity of 0,6 m/s a lubricant having $v_1 = 600 \text{ mm}^2/\text{s}$ should be used.

An operating temperature not exceeding 40 °C is assumed. The grease used has a base oil viscosity of 200 mm^2/s at the operating temperature. Thus

$$\kappa = v / v_1 = 200 / 600 = 0,33$$

In this case, fig. 2.4 shows a factor c_2 of between 0,18 and 0,6. The lower value applies to mineral oils without additives and the upper value to mineral oils with approved EP additives. As SKF greases are subjected to constant quality control, their properties in terms of extended bearing life can be relied upon.

Thus:

$$c_2 = 0,6$$

– Factor for stroke length: The ratio of stroke length to bearing width is

$$l_s / l_t = s / C = 600 / 45 = 13,3$$

and thus, according to table 2.1:

$$f_s = 1$$

The adjusted rating life becomes

$$\begin{aligned}L_{10h} &= c_1 \cdot c_2 \cdot 5 \cdot 10^7 / (s \cdot n \cdot 60) \cdot \\ &\quad (C_{eff} / P)^3 \\ &= 1,0 \cdot 0,6 \cdot 5 \cdot 10^7 / (600 \cdot \\ &\quad 30 \cdot 60) \cdot (3\,822 / 400)^3\end{aligned}$$

$$L_{10h} = 24\,200 \text{ operating hours}$$

The checking of the static safety factor is given by

$$s_0 = f_{i0} \cdot f_{h0} \cdot C_0 / P_0 = 1 \cdot 0,56 \cdot 5\,500 / 400 = 7,7$$

Because of the high static load safety it can be assumed that the operation of the bearing unit will not be impaired through load-related mechanical deformation.

System stiffness k (solid shaft): For a linear ball bearing LBCD 20, assumed to be clearance-free, an elastic bearing deflection of 2 μm can be obtained from fig. 3.9 with $P_0 / C_0 = 400 / 5\,500 = 0,073$.

Bending at the points of application of load due to the bearing's own weight and an externally applied load $P' = 100 \text{ N}$ for a clamped shaft:

$$\begin{aligned}f_{E,ges} &= f_{EG} + f_{EL} \\ &= 2,49E^{-07} \cdot [a \cdot (l - a) / D]^2 + 0,0165 \\ &\quad \cdot P' \cdot a^3 \cdot (2 - 3a / l) / D^4 \\ &= 2,49E^{-07} \cdot [457,5 \cdot (1\,000 - 457,5) \\ &\quad / 20]^2 + 0,0165 \cdot 100 \cdot 457,5^3 \cdot (2 \\ &\quad - 3 \cdot 457,5 / 1\,000) / 20^4 \\ &= 38 + 619 = 657 \mu\text{m}\end{aligned}$$

Thus for a system "shaft clamped at both ends" the total stiffness becomes:

$$\begin{aligned}k_{E,ges} &= F / f_{E,ges} \\ &= 400 / 657 = 0,61 \text{ N} / \mu\text{m} \\ &\text{(maximum value)}\end{aligned}$$

Bending in the points of application of load due to the bearing's own weight and an externally applied load $P' = 100 \text{ N}$ for a freely supported shaft:

$$\begin{aligned}f_{F,ges} &= f_{FG} + f_{FL} \\ &= 2,49E^{-07} \cdot a \cdot (l^3 + a^3 + 2a^2l) / D^2 + \\ &\quad 0,0165 \cdot P' \cdot a^2 \cdot (3l - 4a) / D^4 \\ &= 2,49E^{-07} \cdot 457,5 \cdot (1\,000^3 - 457,5^3 \\ &\quad + 418\,612\,500) / 20^2 + 0,0495 \cdot \\ &\quad 100 \cdot 457,5^2 \cdot (1\,000 - 4 \cdot 457,5 / 3) / 20^4 \\ &= 191 + 2\,525 = 2\,716 \mu\text{m}\end{aligned}$$

Thus for a system “freely supported shaft” the total stiffness becomes:

$$k_{F,ges} = F / f_{F,ges} = 400 / 2\,716 = 0,15 \text{ N} / \mu\text{m} \text{ (minimum value)}$$

The degree of clamping can be verified by conducting measurements.

It is recommended that the bending calculation be checked in the middle of the shaft.

a) shaft clamped at both ends

$$f_{E,max,ges} = f_{max,EG} + f_{max,EL}$$

$$\begin{aligned} &= 1,56E-08 \cdot l^4 / D^2 + 0,00412 \cdot P' \cdot a^2 \cdot (3l - 4a) / D^4 \\ &= 1,56E-08 \cdot 1\,000^4 / 20^2 + 0,00412 \cdot 100 \cdot 457,5^2 \cdot (3\,000 - 1\,830) / 20^4 \\ &= 39 + 630 = 669 \mu\text{m} (> 658 \mu\text{m} = 38 + 620 \text{ under load } P') \end{aligned}$$

b) shaft freely supported at both ends

$$f_{F,max,ges} = f_{max,FG} + f_{max,FL}$$

$$\begin{aligned} &= 7,79E-08 \cdot l^4 / D^2 + 0,00412 \cdot P' \cdot a \cdot (3l^2 - 4a^2) / D^4 \\ &= 7,79E-08 \cdot 1\,000^4 / 20^2 + 0,00412 \cdot 100 \cdot 457,5 \cdot (3 \cdot 1\,000^2 - 4 \cdot 457,5^2) / 20^4 \\ &= 195 + 2\,548 = 2\,743 \mu\text{m} > 2\,716 \mu\text{m} = 191 + 2\,525 \end{aligned}$$

Tolerances

In the catalogue, the dimensions referring to bearing arrangements based on linear ball bearings are to ISO 10285. SKF linear ball bearings are manufactured to the tolerances indicated in tables 3.2 to 3.4.

Tolerance symbols used in the tables are explained below. The indicated maximum and minimum values refer to the permissible deviation from the nominal values shown in the table.

F_w	nominal inscribed diameter of the ball set
F_{ws}	largest and smallest inscribed diameter measurements of the ball set
C	largest and smallest width measurements of linear ball bearing
C_3	largest and smallest measured distance between the grooves in the outside cylindrical surface of a linear ball bearing

Dimensional and form accuracy of bearing housing

The accuracy of a cylindrical seating in a housing must correspond to the precision of the bearing being used. This means that the dimensional tolerance of the housing bore should be at least H7 and preferably H6, whereby the cylindricity tolerance should be to DIN-ISO 1101 for bearing seatings, from 1 to 2 IT grades better than the dimensional tolerance.

Roughness of bearing seating surfaces

The roughness of the bearing seating surfaces does not have the same effect on the functioning of a bearing as the dimensional and form accuracy. On the other hand the required degree of ease in fitting will be more easily maintained, the smoother the mating surface. The following guideline values may be used for the surface roughness rating R_a

- Diameter tolerance IT7:
 R_a 1,6 μm (N7)
- Diameter tolerance IT6:
 R_a 0,8 μm (N6)

Table 3.2 Tolerances for LBBR linear ball bearings

F_w	F_{ws}		C	
	max	min	max	min
mm	μm		μm	
3	+12,5	-1,5	+180	-180
4	+15	-3	+215	-215
5	+15	-3	+215	-215
6	+15	-3	+260	-260
8	+18	-4	+260	-260
10	+18	-4	+260	-260
12	+21,5	-5,5	+260	-260
14	+21,5	-5,5	+260	-260
16	+21,5	-5,5	+260	-260
20	+26	-7	+260	-260
25	+26	-7	+310	-310
30	+26	-7	+310	-310
40	+31	-8	+370	-370
50	+31	-8	+370	-370

Table 3.3 Tolerances for LBCR, LBCB, LBCT, LBCF and LBHT linear ball bearings to L7, ISO 10285

F_w	F_{ws}		C		C_3	
	max	min	max	min	max	min
mm	μm		μm		μm	
5	+12	0	0	-520	+270	0
8	+15	0	0	-520	+270	0
12	+18	0	0	-620	+330	0
16	+18	0	0	-620	+330	0
20	+21	0	0	-620	+390	0
25	+21	0	0	-740	+390	0
30	+21	0	0	-740	+460	0
40	+25	0	0	-740	+460	0
50	+25	0	0	-870	+460	0
60	+30	0	0	-1000	+540	0
80	+30	0	0	-1000	+630	0

Table 3.4 Theoretical and predicted operating clearance of mounted LBAR, LBBR, LBCR, LBCD, LBCT, LBCF and LBHT linear ball bearings

Designation	Theoretical and predicted operating clearance											
	with shaft tolerance h6 and housing tolerance						with shaft tolerance h7 and housing tolerance					
	H6 max	min	J6 max	min	K6 max	min	H7 max	min	J7 max	min	K7 max	min
μm						μm						
LBBR 3	28	-2	24	-6	21	-9	38	-2	31	-9	28	-12
	22	4	17	-1	15	-3	29	7	21	-1	19	-3
LBBR 4	32	-3	28	-7	25	-10	42	-3	35	-10	32	-13
	25	4	20	-1	18	-3	33	6	26	-1	23	-4
LBBR 5	32	-3	28	-7	25	-10	42	-3	35	-10	32	-13
	25	4	20	-1	18	-3	33	6	26	-1	23	-4
LBBR 6	34	-3	29	-8	25	-12	45	-3	37	-11	33	-15
	27	4	22	-1	18	-5	35	7	27	-1	23	-5
LBBR 8	38	-4	33	-9	29	-13	51	-4	43	-12	39	-16
	30	4	25	-1	21	-5	40	7	32	-1	28	-5
LBBR 10	38	-4	33	-9	29	-13	51	-4	43	-12	39	-16
	30	4	25	-1	21	-5	40	7	32	-1	28	-5
LBBR 12	46	-6	41	-11	35	-17	61	-6	52	-15	46	-21
	36	4	31	-1	25	-7	47	8	38	-1	32	-7
LBBR 14	46	-6	41	-11	35	-17	61	-6	52	-15	46	-21
	36	4	31	-1	25	-7	47	8	38	-1	32	-7
LBBR 16	50	-7	45	-12	39	-18	65	-7	56	-16	50	-22
	40	3	35	-2	29	-8	51	7	42	-2	36	-8
LBBR 20	52	-7	47	-12	41	-18	68	-7	59	-16	53	-22
	41	4	36	-1	30	-7	53	8	44	-1	38	-7
LBBR 25	55	-7	49	-13	42	-20	72	-7	61	-18	54	-25
	43	5	37	-1	30	-8	56	9	45	-2	38	-9
LBBR 30	55	-7	49	-13	42	-20	72	-7	61	-18	54	-25
	43	5	37	-1	30	-8	56	9	45	-2	38	-9
LBBR 40	66	-8	60	-14	51	-23	86	-8	74	-20	65	-29
	52	6	46	0	37	-9	67	11	55	-1	46	-10
LBBR 50	66	-8	60	-14	51	-23	86	-8	74	-20	65	-29
	52	6	46	0	37	-9	57	11	55	-1	46	-10
LBAR 5	31	0	26	-5	22	-9	42	0	34	-8	30	-12
	25	6	20	1	16	-3	33	9	25	1	21	-3
LBAR 8	35	0	30	-5	26	-9	48	0	40	-8	36	-12
	28	7	23	2	19	-2	38	10	30	2	26	-2
LB ... 12	42	0	37	-5	31	-11	57	0	48	-9	42	-15
	33	9	28	4	22	-2	45	12	36	3	30	-3
LB ... 16	42	0	37	-5	31	-11	57	0	48	-9	42	-15
	33	9	28	4	22	-2	45	12	36	3	30	-3
LB ... 20	50	0	44	-6	37	-13	67	0	56	-11	49	-18
	40	10	34	4	27	-3	53	14	42	3	35	-4
LB ... 25	50	0	44	-6	37	-13	67	0	56	-11	49	-18
	40	10	34	4	27	-3	53	14	42	3	35	-4
LB ... 30	50	0	44	-6	37	-13	67	0	56	-11	49	-18
	40	10	34	4	27	-3	53	14	42	3	35	-4
LB ... 40	60	0	54	-6	45	-15	80	0	68	-12	59	-21
	48	12	42	6	33	-3	63	17	51	5	42	-4
LB ... 50	60	0	54	-6	45	-15	80	0	68	-12	59	-21
	48	12	42	6	33	-3	63	17	51	5	42	-4
LB ... 60	71	0	65	-6	53	-18	95	0	82	-13	70	-25
	56	15	50	9	38	-3	75	20	62	7	50	-5
LB ... 80	71	0	65	-6	53	-18	95	0	82	-13	70	-25
	56	15	50	9	38	-3	75	20	62	7	50	-5

Operating clearance

The combination of housing bore tolerance, radial clearance of the unmounted linear ball bearing, shaft diameter and linear ball bearing design results in a certain amount of total clearance of the mounted bearing. The predicted operating clearance for the various bearing designs may be obtained from table 3.4 for shaft tolerances of h6 and h7 and the normal housing bore tolerances. While the first line states the theoretically possible limiting values of the operating clearance after mounting, the second indicates the limiting values reached with a more than 99 % reliability assuming Gaussian normal distribution of individual tolerances.

With relatively rough housing bores or during running in, this operating clearance can be increased by smoothing. At operating temperature, the ambient temperature as well as the temperature of the shaft, bearing and housing and the housing material also influence the operating clearance. This should be taken into consideration during installation (see following calculation example).

Calculation of operating clearance

A linear ball bearing LBBR 30 is mounted into an aluminium housing with h6/K6 at a temperature of $T_M = 20\text{ °C}$. The ambient temperature at the installation location is $T_U = 24\text{ °C}$. During operation there are steady-state temperatures measured at $T_W = 34\text{ °C}$ (shaft), $T_L = 43\text{ °C}$ (bearing outer ring) and $T_G = 32\text{ °C}$ (mean housing temperature relevant for the thermal expansion of the bore). We expect values for the diameter-related smoothing for the shaft and housing to be $G_W = 0,5\text{ }\mu\text{m}$ and $G_B = 1,2\text{ }\mu\text{m}$. Housing material is aluminium, the thermal expansion of which is $\alpha_{Al} = 24\text{E-}03\text{ }\mu\text{m/mm}$.

From table 3.4:

max. possible bearing clearance:
-20 to +42 μm , mean value 11 μm
predicted bearing clearance:
-8 to +30 μm , same mean value

At other temperatures a new mean operating clearance may result with different thermal expansion coefficients α , e.g. aluminium housing:

Mean operating clearance,
24 °C = oper. clear., old +
Mean operating clearance,
24 °C = 11 + 2 = 13 μm

Another mean operating clearance value will be reached at steady-state temperature:

Mean operating clearance, $l_{fd} =$
oper. clear, new + $[\alpha_{Al} \cdot D \cdot \delta T_{\text{housing}} -$
 $\alpha_{St} \cdot F_w \cdot \delta T_{\text{shaft}} - \alpha_{St} \cdot (D - F_w) \cdot$
 $\delta T_{\text{bearing}}] = 13 + [24 \cdot 40 \cdot 8 - 11,5$
 $\cdot 30 \cdot 10 - 11,5 \cdot 10 \cdot 19] \cdot 1\text{E-}03$
Mean operating clearance, $l_{fd} = 13$
 $+ [7\ 680 - 3\ 450 - 2\ 185] \cdot 1\text{E-}03$
 $= 15,0\text{ }\mu\text{m}$

After running-in the mean value of the operating clearance M_W increases by $G_W + G_B = 1,7\text{ }\mu\text{m}$. Thus the mean clearance at operating temperature M_W , operation = 15,0 + 1,7 = 16,7 μm . As the scatter of the bearing clearance remains unchanged, the operating clearance finally results in:

Theoretical $16,7 \pm 32 = -15,3 \dots$
 $+48,7\text{ }\mu\text{m}$

Predicted (> 99 %): $16,7 \pm 19,5 = -$
 $2,8 \dots +36,2\text{ }\mu\text{m}$

Accuracy of guidance of linear ball bearing guides

The accuracy of guidance required is an important factor to be considered when selecting the appropriate type of linear guidance system for any particular application. In the case of linear ball bearings, this is influenced by the manufacturing tolerance of the shaft as well as the precision of the adjacent components and by the mounting.

Steel shafts for linear ball bearings should, like the bearing raceways, be hardened and ground. They should have a surface hardness of at least 58 HRC and the surface roughness Ra measured according to DIN 4768, Part 1, which should not exceed 0,32 μm .

Suitable steels for the shafts of linear ball bearing guides include the unalloyed high-grade steels Cf53 (material no. 1.1213) and Ck53 (material no. 1.1210), which are used for the precision shafts available from SKF. The requisite case depth depends on the shaft diameter and will be found in table 3.5.

Table 3.5 Minimum case depths of guide shafts

Shaft diameter		Case depth
over	incl.	min
mm		mm
10	-	0,4
10	18	0,6
18	30	0,9
30	50	1,5
50	80	2,2

The dimensional and form accuracy of precision shafts, as previously mentioned, are important factors in the accuracy of linear guidance. The main characteristics are broadly covered by ISO 13012:

- Diameter tolerance
- Out of round. Excessive deviation from roundness can lead to uneven load distribution in a linear ball bearing which in turn may result in overloading of the individual raceways.
- Deviations in cylindricity. This factor is of particular importance in determining the accuracy of guidance of a linear ball bearing due to momentary distortion of the outer surface of the shaft.
- Straightness of the shaft. The straightness of shafts in unloaded

condition is of secondary importance, since the load on supported shaft carriers and the deflection of free shaft guides are of greater significance. The established values are shown in the tables 3.6 and 3.7.

Influence of mounting on accuracy of guidance

For supported shaft guides, the accuracy of guidance is determined by the parallelism of the individual shaft supports, the difference in height between these, the elastic deformation of the shaft through fixing bolts, and the accuracy of the machine frame.

The maximum deviations from parallelism, lateral tolerance and height tolerance are as follows:

- parallelism 20 μm
- lateral tolerance 20 μm
- height tolerance 40 μm

Allowing for overlap of the tolerances, one may assume a total operating tolerance, composed of parallelism and height tolerance, in the order of 40 μm .

A thorough investigation has been carried out in order to determine the effect of the fixing bolts on elastic deformation. It has been established that the outer diameter of the upper-most part of the shaft is deformed downwards by 5 μm to 20 μm with normal tightening torque on the bolts.

To summarise it may be said that a linear guidance system fitted with linear ball bearings is capable of

Table 3.6 Guide shaft tolerances h6

Shaft diameter		Diameter tolerance		Out of round	Cylindricity	Straightness per meter
more than	to	max	min	max	max	max
mm		μm		μm	μm	μm
3	6	0	-8	4	5	150
6	10	0	-9	4	6	120
10	18	0	-11	5	8	100
18	30	0	-13	6	9	100
30	50	0	-16	7	11	100
50	80	0	-19	8	13	100

Table 3.7 Guide shaft tolerances h7

Shaft diameter		Diameter tolerance		Out of round	Cylindricity	Straightness per meter
more than	to	max	min	max	max	max
mm		μm		μm	μm	μm
3	6	0	-12	5	8	150
6	10	0	-15	6	9	120
10	18	0	-18	8	11	100
18	30	0	-21	9	13	100
30	50	0	-25	11	16	100
50	80	0	-30	13	19	100

yielding an accuracy in the order of 50 µm to 100 µm per 1 000 mm, without taking account of any influence of the supporting structure.

Permissible operating conditions

The correct functioning of a linear ball bearing guidance system can only be maintained if the principal operating limits are not exceeded. The validity of the operating life calculations depends on the observance of the operating conditions described below.

Permissible maximum load

ISO 14728 stipulates that the calculation of bearing life is valid only when the equivalent dynamic loading of a linear ball bearing does not exceed 0,5 of the C rating. Any higher loading leads to erratic stress distribution which can have a negative effect on the life of the bearings. Where such conditions exist the user should seek advice on the calculation of bearing life.

Requisite minimum load

In order to assure slip-free running of a linear ball bearing, the load must be kept higher than a certain minimum value. As a general guideline, a load of $P = 0,02 \cdot C$ is acceptable. Minimum load is of especial importance in linear guidance systems which operate at high speed or with high acceleration. In such cases the inertia forces of the balls and the friction within the lubricant can have an adverse effect on the rolling conditions in the bearing and can lead to damaging slip conditions between the rolling elements and raceways.

Permissible operating temperature

The permissible operating temperature range for SKF linear ball bearings is from -20 °C to +80 °C and is dictated by the cage and seal materials and applies to continuous operation. Lower and higher temperatures can be tolerated for brief periods.

Permissible speed and acceleration

Permissible speed and acceleration are mainly determined by the contact forces between the balls and raceway. Under normal operating conditions, in particular when the minimum load is observed, the permissible speed is 5 m/s and the permissible acceleration is 100 m/s². Higher running speeds and further acceleration are possible, depending on the bearing design, bearing size, applied load, lubricant and bearing preload. In such cases it is recommended that SKF be asked for advice.

Stationary conditions

Damage can occur to linear ball bearings where they may be stationary for long periods and subjected to vibration from external sources. Micro-movement in the contact zone between rolling elements and raceways can damage the surfaces. This will cause significant increase in running noise and premature failure through material fatigue. Damage of this kind through vibration when stationary should be avoided at all costs, for instance by isolating the bearings from external vibration and taking suitable precautions during transport.

Friction

Friction in a linear guidance system is affected, apart from the loading, by a number of other factors, notably the type and size of the bearing, the operating speed, as well as the quality of the lubricant and the quantity of lubricant used.

The cumulative running resistance of a linear ball bearing is defined by the level of several factors: the rolling and sliding friction at the rolling elements' contact zone, friction at the points of sliding contact between the rolling elements and cage as well as at the guiding surfaces of the ball return zones. Running resistance is also governed by the extent of friction within the lubricant and friction from the contact seals in the case of sealed bearings.

The coefficients of friction for lubricated linear ball bearings with shield(s) (non-contact seals) are between 0,0015 (heavy loads) and 0,005 (light loads).

In bearing arrangements with contact single- and double-lip seals the coefficient of friction will be higher due to the added friction from the seals. Values of the sliding friction and starting friction forces for linear ball bearings sealed at both ends can be obtained from tables 3.8 and 3.9.

For lightly loaded linear ball bearings, the lubricant has a marked effect on the frictional properties. Linear ball bearings lubricated with a grease having a minimum viscosity in accordance with our recommendations, will give a correspondingly higher level of basic friction due to the shearing stresses within the grease. This effect will however be reduced to a minimum after a certain time as the grease inside bearing becomes evenly distributed and the surplus is removed from the ball circuits (running-in effect).

Factory pre-lubrication

SKF offers standard factory pre-lubrication for all linear ball bearings from size 6 upwards, which allows for significantly extended relubrication intervals. Many applications do not require any relubrication at all since the theoretical relubrication interval extends the grease and product life cycles. This applies to cases where closed linear bearings with double-lip seals on both sides are used (order designation 2LS). This sealing concept and the internal design of the linear bearings, which incorporates

lubricant reservoirs, enable effective lubricant supply to the bearing position. SKF high-performance LGEP 2 lubricating grease is used here.

Special operating conditions such as elevated operating temperatures, high travel speeds or long strokes (> 50 * bearing width C) can necessitate relubrication (detailed information on relubrication intervals see Fig. 2.7). In this case, the use of LGEP 2 grease is recommended. However, if different lubricants are included in the plant's lube route, miscibility has to be ascertained. Only lubricants having key parameters similar to the SKF lubricating grease (see Table 2.11) should be used.

If the lubricating grease used contains the same thickener (lithium soap in the case of LGEP 2) and a similar type of mineral base oil, it is considered to be miscible with the recommended SKF grease. Lithium soap greases with synthetic ester basis oils or polyalphaolefins (PAO) are compatible with LGEP 2. The manufacturer must be consulted to ascertain the miscibility of lubricating greases having different compositions.

Lubrication

For SKF recommendations on lubrication and the selection of suitable lubricants please refer to the corresponding section in "Basic technical principles".

In order to function efficiently, rolling bearings need sufficient lubrication to prevent metallic contact between the individual rolling elements as well as between these elements and raceways and return paths. This reduces friction and at the same time provides protection of the surfaces against corrosion.

Grease lubrication

Under normal operating conditions, linear ball bearings can be lubricated with grease in the majority of applications. Grease has the advantage over oil that it is more easily retained in the bearing – particularly when shafts are inclined or vertical – and it furthermore contributes to sealing the bearing against the ingress of contaminants, damp or water.

The grease should be applied before mounting by spreading it on the balls which should then be turned several times. For bearings with contact seals (suffix LS or 2LS) it is also recommended that grease be applied behind the sealing lip. With motorised or pneumatic relubrication devices there is a danger of excess lubrication and that seals can become loose. When such devices are used, the seals should be checked for correct fit after relubrication.

Base oil viscosity

The statements regarding the importance of the oil viscosity for the formation of an oil film to separate the bearing surfaces and thus for the life of a bearing in the paragraph "Factor c_2 for operating conditions" in the general technical section, are equally valid for the base oil viscosity of lubricating greases.

Table 3.8 Sliding and starting friction values for LBBR linear ball bearings with two seals

Bearing size	Frictional force	Starting friction
	N	N
3	0,4	1,0
4	0,5	1,3
5	0,6	1,7
6	0,7	2,0
8	0,8	2,5
10	1,0	3,5
12	1,5	5,0
14	1,8	6,0
16	2,0	7,0
20	2,5	8,0
25	4,0	12,0
30	5,5	16,0
40	6,5	20,0
50	8,0	24,0

Table 3.9 Sliding and starting friction values for LBCR, LBCD, LBCT, LBCF and LBHT linear ball bearings with two seals

Bearing size	Frictional force	Starting friction
	N	N
5	0,8	2
8	1,5	4
12	2	6
16	3	9
20	4	12
25	5	14
30	6	18
40	8	24
50	10	30
60	12	36
80	15	45

Commercially available greases for bearings have a base oil viscosity of between 15 and 500 mm²/s at 40 °C. Greases based on oils having higher viscosities than this bleed oil so slowly that the bearing will not be adequately lubricated. Therefore if a very high viscosity is required because of low speeds, oil lubrication will generally be more reliable.

Consistency

Greases are divided into various consistency classes according to the National Lubricating Grease Institute (NLGI) Scale (DIN 51 818). Metallic soap thickened greases of consistency 1, 2 or 3 are those normally used for linear ball bearings. Within the normal operating temperature range and under normal operating conditions the consistency should not vary appreciably. Greases which soften at higher temperatures may, under some circumstances, leak from the bearing. Those which become very viscous at low temperatures can impair the operation of the bearing. If the linear ball bearing is subjected to frequent vibration, exceptional demands are placed on the grease. For such applications, greases with high mechanical stability should be selected.

Temperature range

The temperature range over which a grease can be used depends largely on the type of base oil and thickener used as well as the additives.

The lower temperature limit, i.e. the lowest temperature at which the grease will allow the bearing to be started up without difficulty, is largely determined by the type of base oil and its viscosity. The upper temperature limit is governed by the type of thickener and indicates the maximum temperature at which the grease will provide lubrication for a

bearing. Grease will age and oxidise with increasing rapidity as the temperature increases and the by-products of oxidation have a detrimental effect on lubrication. The upper temperature limit should not be confused with the “drop point” quoted by the lubricant manufacturers. This only indicates the temperature at which the grease loses its consistency and becomes fluid.

Table 2.10 gives the operating temperature ranges for the types of grease normally used for linear ball bearings. These values are based on extensive testing carried out by SKF laboratories and may differ from those quoted by lubricant manufacturers. They are valid for commonly available greases having a mineral oil base and with no EP additives. Of the grease types listed, lithium and more particularly lithium 12-hydroxystearate base greases are those most used for bearing lubrication.

Greases based on synthetic oils, e.g. ester oils, synthetic hydrocarbons or silicone oils, may be used at temperatures above and below the operating temperature range of mineral oil based greases.

Load carrying capacity

For heavily loaded linear ball bearings it has been customary to recommend the use of greases containing EP additives, since these additives increase the load carrying capacity of the lubricant film. Originally, most EP additives were lead-based compounds and there was evidence to suggest that these were beneficial in extending bearing life where lubrication was otherwise poor, i.e. when $\kappa < 1$. However, for the reasons cited above, many lubricant manufacturers have replaced the lead-based additives by other compounds, some of which have been found to be aggressive to bearing steels. Drastic reductions in

bearing life have been recorded in some instances.

The utmost care should therefore be taken when selecting an EP grease and an assurance should be obtained from the lubricant manufacturer that the EP additives incorporated are not of the damaging type. In cases where the grease is known to perform well a check should be made that its formulation has not been changed.

Relubrication intervals

For grease lubricated linear guides, the lubrication interval depends primarily on the average running speed, the operating temperature and the grease quality. The relubrication intervals quoted in fig. 3 are valid for a fixed installation operating under normal load and lubricated with greases of good quality and where the temperature in the bearing does not exceed +70 °C. They should be considered as guideline values and are normally safe to observe. In case of doubt SKF should be consulted.

To take account of the accelerated ageing of the grease with increasing temperature it is recommended that

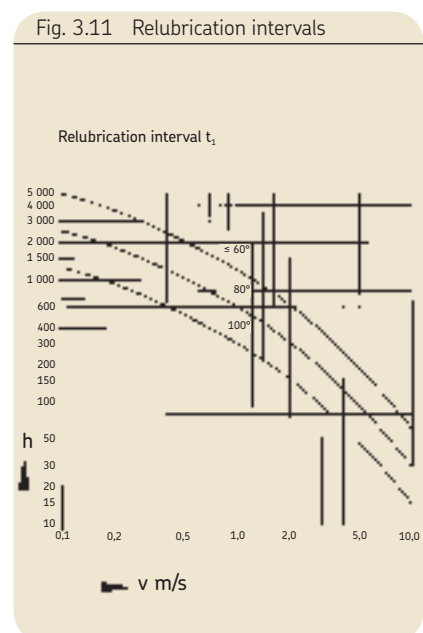

the intervals obtained from the diagram are halved for every 15 °C increase in bearing temperature above +70 °C, remembering that the maximum operating temperature for the bearing or the grease should not be exceeded. At a temperature of +100 °C, for instance, it should be reduced to one fourth of the normal value at +70 °C. The maximum operating temperature for the bearing or the grease should not be exceeded. It should also be noted that the relubrication intervals can vary considerably between apparently equivalent greases. Further information on general aspects of lubrication can be found in GfT work sheet 3 published by Gesellschaft für Tribologie e.V., Moers, Germany.

Relubrication

Rolling bearings have to be relubricated if the service life of the grease used is shorter than the expected service life of the bearing. A bearing should always be relubricated at a time when lubrication conditions are still satisfactory.

Relubrication intervals depend on many inter-related, complex factors. These include bearing type and size, speed, operating temperature, grease type, space around the bearing and the bearing environment. It is only possible to base recommendations on statistical rules.

The information given in the preceding section is based on long-term tests in various applications but does not apply to those where water and/or solid contaminants can penetrate the bearing arrangement. In such cases it is recommended that the grease be more frequently replenished or renewed to remove contaminants or moisture from the bearing.

Relubrication of linear ball bearing arrangements should be carried

out in accordance with one of the following procedures, depending on the given interval:

- If the relubrication interval is shorter than 6 months, then it is recommended that the grease fill in the bearing arrangement be replenished at intervals equal to half the prescribed period. The complete grease fill should be replaced after three replenishments, at the latest.
- When lubrication intervals are longer than 6 months it is recommended that all used grease be removed from the bearing arrangement and replaced by fresh grease.

The six-month limit represents a very rough guideline recommendation and may be adapted to fall in line with lubrication and maintenance recommendations applying to the particular machine or plant.

Replenishment

By adding small quantities of fresh grease at regular intervals the used greases in the bearing arrangement will be only partially replaced. Suitable quantities to be added can be obtained from

$$G_p = 0,0005 \cdot D \cdot C$$

when re-greasing or

$$G_p = 0,0095 \cdot D \cdot C$$

for initial lubrication or complete lubricant exchange

where

- G_p grease quantity to be added when replenishing, g
- D bearing outside diameter, mm
- C overall width of the linear ball bearing, mm

Lubrication nipple

In order to assure efficient lubrication, all SKF linear bearing units of

ISO series 3 from sizes 12 to 80, with the exception of flanged units, are provided with lubrication nipples. These nipples are also available separately and may be used for relubrication purposes as well as for retaining the LBCR, LBCD, LBCT and LBCF linear ball bearings.

Oil lubrication

Oil is generally used for rolling bearing lubrication when high speeds and/or operating temperatures preclude the use of grease, or when frictional or applied heat has to be transported away from the bearing position. It is also used when adjacent components are already oil-lubricated.

Lubricating oils

As a rule only high-grade mineral oils containing additives to improve certain oil properties such as quality under extreme pressure, the effect of ageing etc. are recommended for the lubrication of linear ball bearings. However the formation of a separating oil film can still not be guaranteed.

The remarks covering EP additives in the section on greases, entitled "Load carrying capacity", also apply to EP additives in oils.

Selection of lubricating oil

The selection of an oil is primarily based on the viscosity required to provide adequate lubrication for the bearing.

The viscosity of a lubricating oil is temperature dependent, becoming lower as the temperature rises. The viscosity/temperature relationship of a given oil is characterised by the viscosity index V_i . The lower the variation of viscosity with temperature, the higher the viscosity index. For rolling bearing lubrication, oils having a viscosity index greater than 85 are recommended.

In order for a sufficiently thick film of oil to be formed in the contact area between rolling elements and raceways, the oil must retain a certain minimum viscosity at the operating temperature. The kinematic viscosity ν_1 required at the operating temperature to ensure adequate lubrication can be determined from the diagram in fig. 2.5. When the operating temperature is known from experience or can otherwise be determined, the corresponding viscosity at the internationally standardised reference temperature of 40 °C can be obtained from the diagram in fig. 2.6. When selecting the oil the following aspects should be considered:

- Bearing life may be extended by selecting an oil whose viscosity ν

at the operating temperature is somewhat higher than ν_1 . However, since increased viscosity raises the bearing operating temperature there is frequently a practical limit to the degree of improvement achievable here.

- If the viscosity ratio $\kappa = \nu/\nu_1$ is less than 1, an oil containing EP additives is recommended and if κ is less than 0,4, the use of an oil with such additives is mandatory. (See also "Factor c_2 for operating conditions")
- For exceptionally low or high speeds, critical loading conditions or for unusual lubricating conditions please consult SKF.

Calculation example

A linear ball bearing of size 20 is required to operate at a mean velocity of $v = 2$ m/s on the shaft. From fig. 2.5, where $F_w = 20$ mm, the minimum kinematic viscosity ν_1 required to give adequate lubrication at the operating temperature is 200 mm²/s. Assuming an operating temperature of 40 °C for the linear ball bearing, which would generally be expected at an ambient temperature of 25 °C in normal service, then the minimum viscosity ν_1 is the same as the viscosity normally quoted for an oil at the standard reference temperature. Where operating temperatures are higher, refer to the viscosity/temperature curve in fig. 2.6 for the correctly specified oil for the minimum viscosity level ν_1 at 40 °C.

Table 3.10 Lubrication nipple for LBC linear ball bearings and LPA linear plain bearings

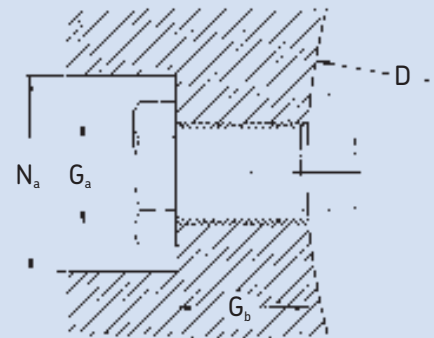
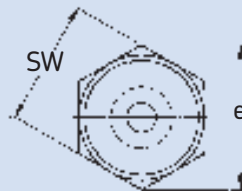
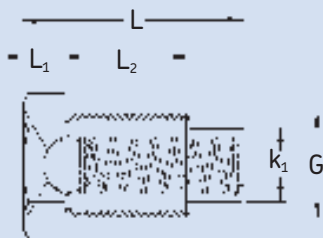

Dimensions		Designation							Abutment dimensions			
Bearing	Lubrication nipple								Housing			
F_w	G	L	L_1	L_2	k_1	e	SW	D	G_a	G_b $\pm 0,2$	N_a min	
mm	—	mm						mm	—	mm		
12	M 4	7,7	1,5	3,5	3,0	5,5	5	VN-LHC 20	22	M 4	3,8	13
16	M 4	7,7	1,5	3,5	3,0	5,5	5	VN-LHC 20	26	M 4	3,8	13
20	M 4	7,7	1,5	3,5	3,0	5,5	5	VN-LHC 20	32	M 4	3,8	13
25	M 5	11,1	2,0	5,0	3,5	6,6	6	VN-LHC 40	40	M 5	5,2	15
30	M 5	11,1	2,0	5,0	3,5	6,6	6	VN-LHC 40	47	M 5	5,2	15
40	M 5	11,1	2,0	5,0	3,5	6,6	6	VN-LHC 40	62	M 5	5,2	15
50	M 6	14,8	2,5	7,0	4,5	7,8	7	VN-LHC 50	75	M 6	7,2	15
60	M 8	20,5	3,5	10,5	6,0	11,1	10	VN-LHC 80	90	M 8	11,2	18
80	M 8	20,5	3,5	10,5	6,0	11,1	10	VN-LHC 80	120	M 8	5,2	18

Application of bearings

Linear guidance arrangements with linear ball bearings may be designed with one or two shafts.

Generally, where one shaft is used, two linear ball bearings are required. Only in exceptional circumstances, e.g. when loads are very light and the parallelism of the shaft or the housing to the axis of movement is ensured by other means, is it possible to use a single linear ball bearing.

In all cases where a single shaft is used it is necessary to prevent the shaft from rotating relative to the bearing, i.e. to the housing, or vice versa. This can be done in a number of ways, for example by arranging a groove in the housing and a key for the shaft (fig. 3.12) or with a pin engaging in a groove (fig. 3.13), or with a cam roller which is guided by a rail or groove.

In most applications, however, the arrangement incorporates two shafts, thus permitting heavier loads and obviating the necessity for special devices to prevent rotation. However, such arrangements place special demands on the parallelism of the shafts and the bores in the housings.

In some cases, e.g. where loads are light, speeds slow, and the stiffness requirements are not particularly stringent, any errors of parallelism of the two shafts can be compensated for by simple means without any detrimental effect on the bearings. It is possible, for example, to mount one shaft securely with accurate alignment, and for the other shaft, or the bearing on it, to align itself. Self-aligning shafts are obtained by a "floating" arrangement for example. Fig. 3.14 shows such an arrangement where springs are used to preload the arrangement so that there is no operating clearance and running noise can be reduced.

Where very long arrangements are required, particularly if they are to be heavily loaded, it is recommended that open SKF linear ball bearings of the LBCT, LBCF or LBHT series be used. Open linear ball bearings allow the shaft to be supported either at intervals or along its whole length. In this way an arrangement having great accuracy and high stiffness can be obtained. Normally the second variant is chosen in practical application.

To facilitate mounting, the shaft ends and housing bore edges should be rounded, the chamfer or lead-in angle being approximately 20° . This

permits the shaft to be inserted without damaging the balls or seals of the bearing, and simplifies the insertion of the bearing in its housing.

The length of chamfer depends on the shaft diameter and is established as follows, in accordance with ISO recommendations covered by ISO/DIS 13012 (table 3.11).

Fig. 3.12

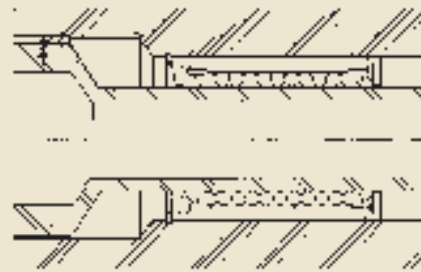

Fig. 3.13

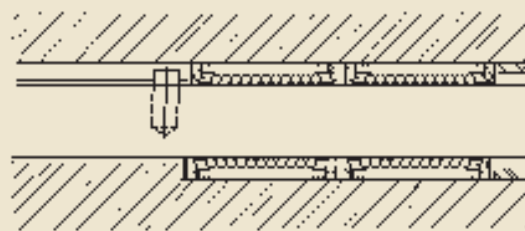

Fig. 3.14



Inaccurate machining of the mounting surfaces can lead to internal stresses when the linear guidance arrangement is bolted in position. The same effect can also occur in the case of a free shaft if the load dependent bending of the shaft exceeds a certain level. In such applications the use of a self-aligning linear ball bearing is recommended. The following chart shows a comparison between the various linear ball bearing designs:

Surface profile	
cylindrical	spherical
LBCR	LBCD
LBCT	LBCF

An important design feature of the LBCD and LBCF bearing is the external profile of the raceway segments. A spherical elevation is ground in the centre of the raceway segment, which allows tilting of the raceway segment through a maximum angle of ± 30 minutes of arc.

In order to ensure proper functioning of the linear ball bearing in its fully-tilted position, the swivelling range of the outside diameter of the cage has been reduced in comparison with the LBCR and LBCT versions. The result is that the entire linear ball bearing follows the self-aligning movement and the seals incorporated in the ends remain concentric to the shaft. This prevents uneven contact with the seal lips and to an associated increase in friction.

Radial location

Satisfactory radial location and support for linear ball bearings can be obtained by machining the seating bore to tolerance H7. The dimensional and form accuracy should conform to the standards described in the paragraph headed "Tolerances". In certain applications, however, a

tighter fit may be called for on account of the operating conditions, requisite running accuracy or necessary clearance.

Tolerances h7 or h6 are those generally recommended for the shaft. Depending on the bearing type and housing bore tolerance, the operating clearance obtained after assembly of the linear guide will be found in table 3.4 (setting aside temperature effects).

Axial location

The two plastic end rings of linear ball bearings LBCR 5 and LBCR 8 have an outside diameter slightly larger than the nominal outside diameter of the bearing. Where accelerations are small, this extra diameter will provide the requisite tightness of fit of the bearing in its housing.

Linear ball bearings of series LBCR, LBCD, LBCT and LBCF, depending on their particular design, require different degrees of force when mounting in the housing. Satisfactory axial location can only be guaranteed if these bearings are fixed within the housing with the aid of the lubrication nipple, SKF designation VN-LHC, or similar means of attachment.

If the width of the housing is equal to – or greater than – that of the bearing and the bearing, under light load, has to accommodate only limited acceleration, no additional means will be necessary to ensure adequate location of the bearing in the housing (fig. 3.15).

However, when the bearing is exposed to vibration or high acceleration or if it projects outside the housing, some means of axial location should be used. Various methods are available, the main ones being described below. In each case, though, care should be taken to ensure that the bearing is not pre-

loaded after mounting but should always show a slight amount of clearance between the mounting surfaces.

Table 3.11 Housing bore edge chamfer for linear ball bearings

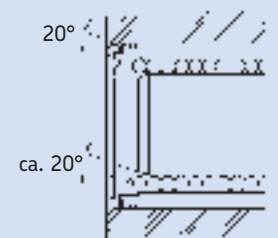

Shaft diameter from	incl.	Length of chamfer minimum
mm		mm
	10	0,8
10	18	1,0
18	30	1,5
30	50	2,0
50	80	2,5

Fig. 3.15

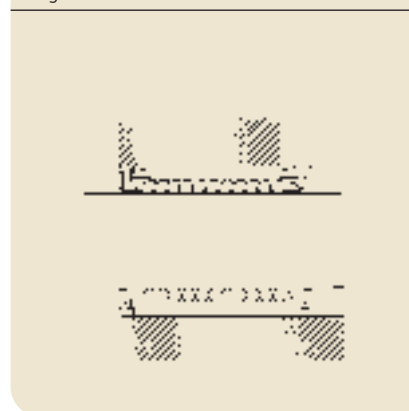

Axial location using retaining rings (figures 3.16 and 3.17) takes little space, enables fast mounting and dismounting and simplifies the machining of the associated components.

When using retaining rings for the location of bearings of the series LBCR and LBCD, the clamping forces of the retaining rings should exert only a light preload to the balls on the shaft via the raceway segments which are loosely held in the cage. However, care should be taken to see that the operating clearance in the bearing arrangement is maintained in the unloaded section of the bearing. The clearance should be between the outside surface of the raceway segments and the housing bore.

Instead of retaining rings, end plates or covers (fig. 3.18) or retaining plates (fig. 3.19) can be screwed to the housing to provide axial location for the bearing.

It is also possible to use a housing shoulder (fig. 3.20) as an abutment or a neighbouring machine component as a spacer sleeve.

Fig. 3.16

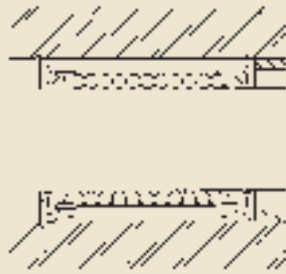

Fig. 3.19

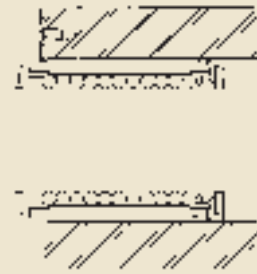

Fig. 3.17



Fig. 3.20

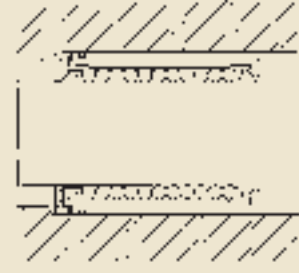
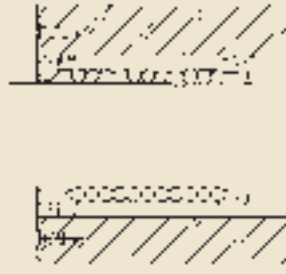

Fig. 3.18



Axial location to prevent turning

Open linear ball bearings of series LBCT, LBCF and LBHT must not only be given adequate axial location, but must be prevented from turning. This is also true of the closed linear ball bearings of series LBCR and LBCE which are to be mounted in a defined position. (See diagrams figures 3.4 to 3.6 “Influence of direction of load”)

Holes are provided in the outside diameter of bearings of series LBCR, LBCE, LBCT and LBCF in which stops can be inserted to prevent the bearing from turning. The following can be used as stops:

- SKF lubrication nipples VN-LHC
- grub screws to DIN 417/ ISO 7435 or DIN 915/ISO 4028
- straight pins to DIN 7
- slotted pins to DIN 1481 or DIN 7346
- grooved pins to DIN 1470 or DIN 1471

The use of VN-LHC lubrication nipples is recommended and they are used for this purpose in linear bearing units. The position and diameter of the holes in the bearing outside diameter as well as the appropriate nipples, grub screws and pins will be found in table 3.12.

On the heavily loaded linear ball bearings of the LBHT series there is insufficient space for holes to provide protection against turning. For this reason one of the lower raceway segments is bored to take the cylindrical set screws to DIN 417 and DIN 915. Dimensions and position of these are indicated in table 3.13. When securing LBHT bearings care must be taken not to over-tighten these screws, otherwise excessive stress may be created, resulting in premature failure of the bearing.

Table 3.12 Turning stops for LBCR, LBCE, LBCT and LBCF linear ball bearings as well as LPA linear plain bearings

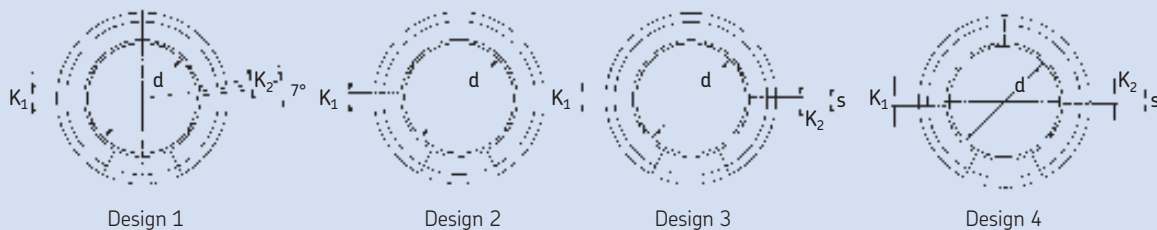

Bearing Size	Holes in cage to take stops Dimensions			Design ¹⁾	Appropriate lubrication nipples ²⁾	Grub screws ³⁾	Pins ⁴⁾ diameter
	K ₁	K ₂	s				
–	mm	–	–	–	–	–	–
12	3,0	3,0	–	1	VN-LHC 20	M 4	3
16	3,0	–	–	2	VN-LHC 20	M 4	3
20	3,0	–	–	2	VN-LHC 20	M 4	3
25	3,5	3,0	1,5	3	VN-LHC 40	M 5	3
30	3,5	3,0	2,0	4	VN-LHC 40	M 5	3
40	3,5	3,0	1,4	4	VN-LHC 40	M 5	3
50	4,5	3,0	2,5	4	VN-LHC 50	M 6	4
60	6,0	5,0	2,5	4	VN-LHC 80	M 8	6
80	8,0	5,0	2,5	4	VN-LHC 80	M 10	8

¹⁾ All linear plain bearings design 2.

²⁾ Recommendations for holes to take lubrication nipples, see table 3.10

³⁾ Grub screws to ISO 7435 and DIN 417 or ISO 4028 and DIN 915.

⁴⁾ Straight pins to DIN 7, slotted pins to DIN 1481 and DIN 7346 or grooved pins to DIN 1470 and DIN 1471.

If for design reasons (e.g. operating clearance adjustment) none of these means can be adopted for the prevention of turning, open linear ball bearings may be retained by means of plates screwed to the housing, as illustrated in figures 3.21 and 3.22.

Mounting

(For information regarding the storage, mounting preparations and cleaning of linear bearings see also “Basic technical principles”)

Skill and cleanliness are essential when mounting SKF linear ball bearings, to obtain optimum performance and to avoid premature bearing failure. SKF linear ball bearings are precision products and should be handled with due care. Above all, the correct mounting procedures should be adhered to and the appropriate tools used at all times. In particular, we refer you to our brochure “Tools for trouble-free operation”.

Linear ball bearings are easy to mount in the housing bore and little force is required. If force is needed to mount the bearings the use of a mechanical or hydraulic press is recommended. It is advisable to use a mandrel between the press and the linear ball bearing. The mandrel, preferably of a plastic material, should be designed to provide guidance to the bearing and to give complete support to the end face so that seal damage is avoided. If the bearing is to be recessed in the housing the mandrel may have the form shown in fig. 3.23, whereas the design in fig. 3.24 should be used when the bearing is to protrude or be flush with it.

When linear ball bearings of the series LBCR, LBCD, LBCT or LBCF are to be mounted and secured against turning, through the use of grease nipples or suitable pins, care should also be taken to ensure that the attachment holes of the cage are aligned with those of the housing. Subsequent rotation of the linear

ball bearing after mounting is no longer possible because of the increased grip. SKF linear ball bearings can be mounted in relatively short housings which are easy to handle using other tools, for example, a puller. If a puller is used (fig. 3.25) it must be ensured that the force acts centrally. If a linear ball bearing is to be mounted in a certain position in the housing it is recommended that a thrust bearing is placed between the mandrel and the spindle of the puller to prevent the linear bearing from turning relative to the housing bore.

Direct blows to the linear ball bearing are to be avoided at all times as these would damage the seals and the cage.

Adjustment of operating clearance

The operating clearance of linear bearing units of series LUCS, LUNE, LUNF and LUCT is set by means of an adjustment screw in the housing. For zero operating clearance, if the application permits, the adjustment

Table 3.13 Turning stops for LBHT linear ball bearings



LBHT design

Bearing Size	Dimensions				Appropriate grub screws DIN 417 DIN 915	Designation Linear - ball bearing
	F_w	K_1	h	α_1		
–	mm	$\pm 0,05$	–	$^\circ$	–	–
20	20	2,6	$1,3 \pm 0,2$	47°	M 4	LBHT 20
25	25	2,6	$1,3 \pm 0,2$	$55^\circ 12'$	M 4	LBHT 25
30	30	3,6	$1,4 \pm 0,2$	$39^\circ 15'$	M 5	LBHT 30
40	40	3,6	$1,4 \pm 0,2$	$39^\circ 51'$	M 5	LBHT 40
50	50	4,1	$1,8 \pm 0,3$	39°	M 6	LBHT 50

Fig. 3.21

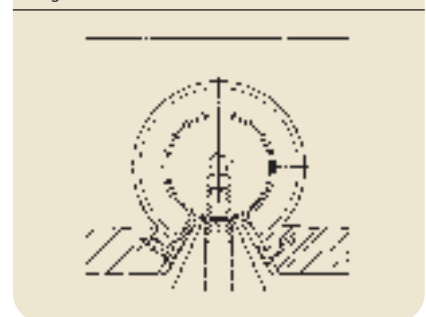

Fig. 3.22



screw should be tightened until a slight resistance can be felt when either the shaft or the housing is turned by hand. Where there are two linear ball bearings on the shaft, the operational clearance of the one bearing is set first and the position marked on the adjustment screw. This is then loosened and the clearance of the second bearing set. It is then only necessary to retighten the adjustment screw of the first bearing to the marked position.

Preload of linear bearings can be applied by the same method except that it is necessary to use a calibrating shaft with a diameter which is smaller than that of the actual shaft by an amount corresponding to the desired preload.

After mounting on the shaft, preloaded or zero-clearance linear bearings should not be rotated as this might lead to marking of the raceways.

Mounting of linear ball bearings in guidance systems

Where a linear guidance system has to run parallel to a given fixed surface, the shaft should be accurately aligned and secured. When mounting it is advisable first to run the linear bearing unit along the shaft. In this way one can avoid loss of balls from the bearing through tipping of the unit relative to the shaft. The mounting of a linear guidance system can be further facilitated by treating the shaft ends in accordance with the recommendations given in the chapter "Application of bearing". This is particularly important when mounting preloaded systems.

In a preloaded system the shaft should be carefully inserted in the pre-set bearing unit, with the latter only lightly attached to the upper plate. The fixing bolts are subsequently tightened.

In the case of guides with zero-clearance or preload, it should be noted that the tolerances of form and fit in the adjacent components can lead to additional stresses when both sides are preloaded and there is no length compensation. In such cases a guidance side with normal tolerance (i.e. H7/h7) is recommended.

Where sealed bearings are concerned, grease should be applied on and behind the sealing lip in order to reduce frictional forces during mounting and to protect the sealing surface against premature wear.

Fig. 3.23

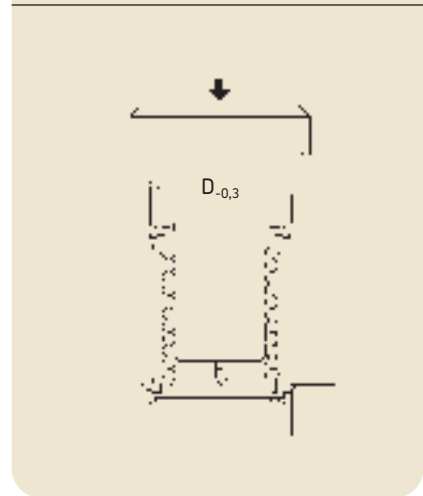

Fig. 3.24

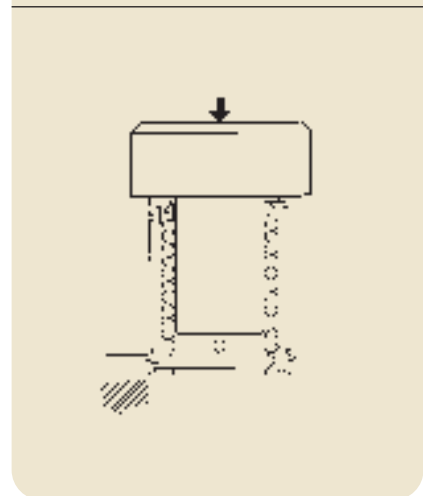
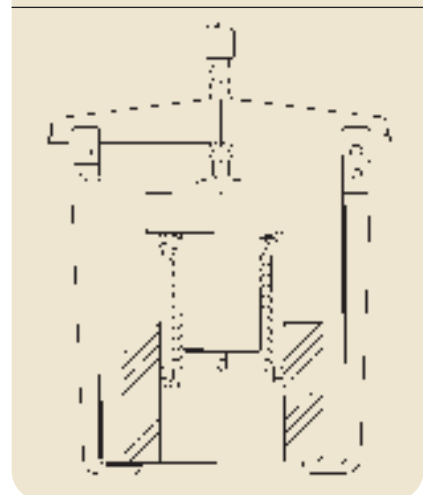

Fig. 3.25



Seals

In addition to correct lubrication, suitable sealing must be provided if the full life of a linear guide is to be obtained under the given operating conditions. As the conditions can vary considerably from one case to another, each must be considered individually, in deciding whether additional seals are required to the integral bearing seals.

Various factors have to be taken into consideration when selecting the appropriate seal for a linear bearing, for instance the design, available space, type and severity of the contaminants, cost aspects, as well as the permissible degree of friction. Simple and effective additional protection can be achieved through fitting a felt seal in the housing cover as shown in fig. 3.26.

Wipers as shown in fig. 3.27 also offer adequate protection for the bearings in heavy duty applications.

Special sealing rings made of rubber or synthetic materials

(fig. 3.28) are commercially available in all sizes, for example, as spare parts for hydraulic cylinders. These can be adapted to suit the linear guide by modifying the housing cover. It should however be remembered that rubbing seals of this kind are intended for severe cases of contamination and that they make a significant addition to the friction of the system.

Under very hostile conditions, particularly where the linear guidance arrangement is exposed to considerable dirt fall-out, water or other corrosive fluids, it is recommended that bellows be used if the stroke length permits.

Fig. 3.26



Fig. 3.27

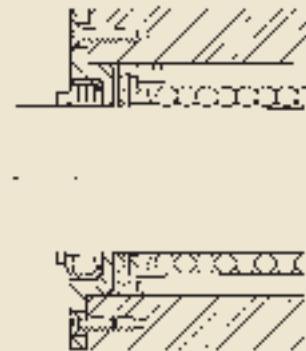
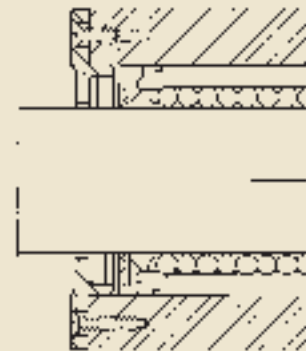

Fig. 3.28



Linear plain bearings for shaft guidance systems

To complement the range of linear guidance systems with rolling elements, two series of linear plain bearings have been developed, having similar external dimensions to those of ISO series 1 and series 3. These bearings can be used in certain applications where the use of rolling element bearings is inappropriate because of extreme operating conditions. This is especially relevant in cases of heavy shock loads, vibration or where high speeds and

acceleration are required under light load conditions. For such applications dry sliding bearings are preferable to linear ball bearings although a greater degree of friction is to be expected.

Bearing types

LPBR linear plain bearings

The dimensions of these bearings correspond to those of ISO series 1 and are interchangeable with linear ball bearings of the LBBR series.

LPAR and LPAT linear plain bearings
Bearings of the LPAR and LPAT series conform to the ISO series 3 dimension specification and are interchangeable with linear ball bearings of the LBCR and LBCT series.

As in the case of linear ball bearings, bearing units are also available in addition to the individual bearings.



Basic technical principles

The suitability of linear plain bearings for a given application depends largely on friction, heat dissipation, sliding properties of the mating surfaces and the efficiency of lubrication. In contrast to linear ball bearings, general statements regarding the service life and performance in specific applications cannot be accurately made. This is due to basic tribological factors such as the surface micro-structure and the effects of roughness and acceleration on the integrity and potential non-homogenous properties of materials. No guidelines can be stipulated as to the wear to be expected in these conditions.

Load carrying capacity

The basic dynamic load rating C is a factor denoting the properties of a linear plain bearing. This denotes the magnitude and direction of the constant load which, under conditions of continuous linear movement at a given speed and at room temperature, gives a certain nominal service life expressed in running distance. Load rating figures are always dependent on the basic definition and therefore the dynamic load ratings stated by different manufacturers are not necessarily comparable.

The basic static load rating C_0 is used when the linear plain bearing is loaded when stationary (or during occasional slight adjustment movement). This factor should also be used where a dynamically loaded linear plain bearing is subjected to heavy shock loads. This gives an indication of the load which can be accepted by a linear plain bearing without exceeding a prescribed degree of distortion of the sliding surface. It is assumed that the components adjacent to the bearing are sufficiently rigid.

Service life

The service life of a linear plain bearing depends in practice upon the positive or negative effect, in the mixed or dry frictional area, of the increase in matching of the surfaces. It is also governed by the bearing clearance and/or the increase in bearing friction determined by the progressive wear of the sliding surfaces, plastic deformation and fatigue of the materials at the sliding surface.

Depending on the application and choice of sliding surfaces, a greater degree of wear or increase in friction is permissible. This also implies that under apparently equal operating conditions, the actual life achievable in practice can vary considerably.

All data relating to the dynamic load rating of SKF linear plain bearings refer to the nominal service life by which it is understood that service life which will be reached or exceeded by the majority of the linear dry sliding bearings. The method of calculation of the nominal operating life has been evolved empirically as a result of numerous laboratory tests. The term effective (actual) life, on the other hand, refers to the life which, in individual cases, under the given operating conditions is actually achieved. This depends not only on the magnitude and type of the load but also on many other influencing factors which are sometimes difficult or impossible to detect. These include dirt, corrosion, high frequency loads or movement cycles, blows, etc.

“pv” load/speed relationship

If the bearing size is dictated by virtue of the dimensions of the adjacent components, the shaft diameter is usually more or less predetermined. A check can then be made to see whether the proposed bearing can in fact be used under the particular operating conditions (load, sliding speed). The required data (specific bearing load) and v (mean sliding speed) can be calculated as follows, whereby v is determined either by the drive relationships or it can be calculated where the stroke and frequency are known.

$$(4.1) \quad v = s \cdot n / 30\,000$$

and

$$(4.2) \quad p = P / (2 \cdot F_w \cdot C_4)$$

where

C_4	width of sliding surface, mm
F_w	bore of linear plain bearing, mm
P	equivalent dynamic bearing load, N
n	stroke frequency, min^{-1} (number of movements from one end position to the other and back again)
p	specific bearing load N/mm^2
s	stroke length, mm
v	mean operating speed, m/s

If the initial check shows that the operating conditions are below the permissible limits indicated in fig. 4.2 “pv diagram for linear plain bearings”, it can be assumed that the life of the bearing will be adequate. If however the maximum limits are exceeded, a larger size of bearing should be selected in order to achieve the required pv value through reduction of the specific surface loading.

Range of applications

The sliding material employed consists of polyacetal incorporating a layer of polyethylene. This combination is particularly suitable for dry sliding bearing applications and is characterised by its excellent resistance to wear. The maximum acceptable load rating is 14 N/mm².

Recommended operating temperatures for continuous operation lie between -40 and +80 °C and for short periods they may reach 120 °C. It should however be noted that the mechanical stability of the synthetic material is temperature dependent and falls from a rating of 100 % at room temperature to some 30 % at 100 °C.

Friction

The frictional qualities of linear plain bearings depend primarily on the loading of the bearing, the sliding speed and the lubrication conditions. In addition, the surface qualities of the mating surface and the operating temperature are of importance.

For linear plain bearings the coefficient of friction for dry running conditions lies between 0,17 and 0,21. The lowest figures for friction are generally obtained with high specific bearing loads and low sliding speeds. Under particularly unfavourable conditions and where the load is low, the indicated maximum values can be exceeded. The sliding material possesses the property of having a 'stiction' or static friction only slightly higher than the sliding friction coefficient and therefore stick-slip is avoided. Sealed linear plain bearings, on account of the additional friction of the sealing lips, show higher friction ratings. The corresponding values for the frictional and starting friction forces can be obtained from tables 3.8 and 3.9.

Tolerances

In order to assure full interchangeability with linear ball bearings, the external dimensions and tolerances of linear plain bearings are identical to those of their ball bearing equivalents. They differ only in the degree of radial clearance which, in accordance with the recommendations for plain bearings, is significantly greater than for linear ball bearings.

The corresponding values can be obtained from the following tables.

During the running-in period, a greater degree of wear will be observed which will lead to additional increase in radial clearance.

Fig. 4.2 pv diagram for linear plain bearings

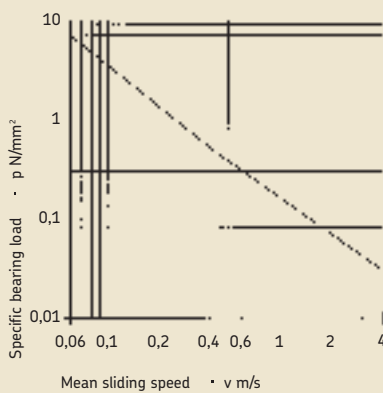

Table 4.1 Radial clearance of LPAR and LPAT series bearings, using housing bore H7 and shaft diameter h7, maximum permissible misalignment of the shaft in the bearing and load index $2 \cdot F_w \cdot C_4$

Shaft diameter	Radial clearance				Misalignment		Load index $2 \cdot F_w \cdot C_4$
	LPAR		LPAT		LPAR	LPAT	
	max	min	max	min			
mm	μm				Minutes of arc		mm ²
5	+110	+55			10,8		70
8	+110	+55			9,5		128
12	+160	+110	+205	+130	15,1	17,9	240
16	+160	+110	+205	+130	12,6	14,9	384
20	+165	+110	+210	+135	10,1	12,4	600
25	+165	+110	+210	+135	7,6	9,3	1000
30	+165	+110	+210	+135	6,6	8,1	1380
40	+165	+110	+215	+140	6,0	7,7	2000
50	+165	+110	+215	+140	5,1	6,4	3000
60	+220	+160	+275	+190	6,3	7,5	4200
80	+220	+160	+275	+190	4,9	5,8	7200

Table 4.2 Radial clearance of LPBR series bearings, maximum permissible misalignment of the shaft in the bearing and load index $2 \cdot F_w \cdot C_4$

Shaft diameter	Radial clearance		Misalignment	Load index $2 \cdot F_w \cdot C_4$
	max	min		
mm	μm		Minutes of arc	mm ²
12	+175	+100	12,3	240
16	+205	+130	14,9	384
20	+210	+135	15,5	520
25	+210	+135	11,6	850
30	+260	+185	12,7	1200
40	+330	+225	12,9	1920
50	+380	+275	13,5	2700

Lubrication

Linear plain bearings may be used with or without lubrication. For protection against corrosion and for improvement of sealing it is advisable in many applications to fill the bearing with lubricating grease. The most suitable greases are the corrosion resistant and water repellent lithium soap types of normal consistency, for instance the SKF LGMT 3 or LGHT 3 greases. On no account should greases containing molybdenum disulphide or other solid lubricants be used.

Bearing arrangements

The specification of required bearing performance is critical to the choice of the material and determining the quality of the mating surface for a linear plain bearing, the required performance of the bearing is of overriding importance. In most cases soft carbon steels with a ground surface are adequate. The roughness ratings R_a and R_z (in accordance with DIN 4768, part 1) should lie in region of $0,4 \mu\text{m}$ and $3 \mu\text{m}$ respectively.

Where the demands on the bearing are more stringent, hardened sliding surfaces with a surface hardness of at least 50 HRC or a surface treatment of the surface, for instance with hard chrome, can be advantageous. In such cases the value of R_a should be in the region of $0,3 \mu\text{m}$ and of R_z about $2 \mu\text{m}$. A higher quality of the surface will also enhance the running qualities whereas a lower quality will result in increased wear.

Housing and shaft tolerances

Satisfactory support of a linear plain bearing can be obtained by machining the seating bore to the appropriate tolerance. For linear plain bearings of the LPBR series a tolerance of H7 is recommended.

On bearings of the LPAR and

LPAT series, the outer diameter is machined slightly under-size. When mounting these bearings, care should be taken to ensure that they are axially located through the use of the appropriate retaining rings. The use of retaining rings (figs 4.3 and 4.4) is particularly economical in terms of space requirements, enables rapid mounting and dismounting and simplifies the manufacture of adjacent components. Additional axial location can be provided by attaching a lubrication nipple in accordance with the guidelines for linear ball bearings of the LBCR and LBCT series (tables 3.12 and 3.13).

Mounting and dismounting

Skill and cleanliness are essential when mounting SKF linear plain bearings, to obtain optimum performance and to avoid premature bearing failure.

The bearings should not be removed from their original packaging until immediately before mounting, in order to avoid contamination. The condition of the shaft and adjacent surfaces should be checked closely in order to ensure that no scratching of the sliding surface of the bearing is caused through any sharp edges or burrs, or that an already damaged shaft is installed.

When mounting a linear plain bearing the use of a mandrel is recommended as in the case of linear ball bearings (see figs 3.23/3.24). To facilitate mounting, the shaft ends should be chamfered to an angle of 10 to 20°. Light oiling or greasing of the bearing faces will then allow easy insertion.

If a tight fit cannot be achieved, for instance due to difficulties in mounting, or because of the available force for insertion, adequate securing in the housing can often be achieved through the use of adhesives. In such cases however an unac-

ceptable degree of increased clearance should be compensated by a corresponding change in shaft tolerance.

Even in applications for which no constant lubrication is intended, it is advisable to apply some lubricant during the running in stage just after mounting. This will serve to lower the coefficient of friction during running in and to increase the life of the bearing.

If after dismounting the bearings are to be reused, they must be handled with the same degree of care as when mounting. The force used in extracting should always act concentrically on the bearing in order to avoid damage to the sliding surfaces.

Fig. 4.3

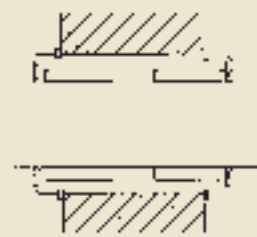
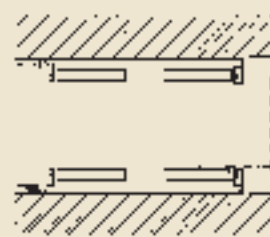

Fig. 4.4





©SKF is a registered trademark of the SKF Group.

©SKF Group 2011

The contents of this publication are the copyright of the publisher and may not be reproduced (even extracts) unless prior written permission is granted. Every care has been taken to ensure the accuracy of the information contained in this publication but no liability can be accepted for any loss or damage whether direct, indirect or consequential arising out of the use of the information contained herein.

PUB MT/P1 06402/1 EN · Oct 2011

This publication supersedes publication 6402 EN - 0612A

Printed in Sweden on environmentally friendly paper.