

# SKF dry lubricated bearings

Reliable performance in high temperature applications





The SKF brand now stands for more than ever before, and means more to you as a valued customer.

While SKF maintains its leadership as a high-quality bearing manufacturer throughout the world, new dimensions in technical advances, product support and services have evolved SKF into a truly solutions-oriented supplier, creating greater value for customers.

These solutions enable customers to improve productivity, not only with breakthrough application-specific products, but also through leading-edge design simulation tools and consultancy services, plant asset efficiency maintenance programmes, and the industry's most advanced supply management techniques.

The SKF brand still stands for the very best in rolling bearings, but it now stands for much more.

**SKF – the knowledge engineering company**

# Contents

## A Product information

<b>Dry lubricant solves lubrication problems</b> . . . . .	<b>3</b>
Introduction to dry lubricant(s) . . . . .	3
<b>SKF DryLube bearings</b> . . . . .	<b>4</b>
Typical applications . . . . .	6
Designs and variants . . . . .	8
Temperature limits . . . . .	8
Maintenance . . . . .	8
Bearing data . . . . .	9
Speed limits . . . . .	10
<b>Extreme temperature bearings</b> . . . . .	<b>11</b>
Typical applications . . . . .	12
Extreme temperature deep groove ball bearings . . . . .	13
Extreme temperature Y-bearings . . . . .	13
Maintenance . . . . .	14
Bearing data . . . . .	14

## B Recommendations

<b>Principles of bearing selection and applications</b> . . . . .	<b>15</b>
Design of bearing arrangements . . . . .	15
Y-bearing arrangements . . . . .	15
Selection of bearing size . . . . .	16
Bearing designation system . . . . .	19
Y-bearings designation system . . . . .	20
Y-bearing units designation system . . . . .	21

## C Product data

Product tables . . . . .	22
Overview of product assortment . . . . .	25

## D Additional information

<b>SKF – the knowledge engineering company</b> . . . . .	<b>26</b>
--	-----------

# Dry lubricant solves lubrication problems

*Equipment that must operate in environments with very high temperatures can be difficult and expensive to lubricate effectively. Inadequate lubrication limits bearing service life – and with it, machine performance and productivity.*

While alternative, extreme temperature lubrication solutions exist, many cause additional problems. Lubricants used to reduce friction can dissipate, evaporate or carbonize at extremely high temperatures.

This not only creates environmental issues, but increases the costs associated with the purchase and disposal of grease as well as the time and manpower to continually relubricate the bearings.

SKF has engineered a range of bearing and lubricant solutions designed specifically to address the challenges of extreme operating conditions. Combining SKF's expertise in advanced materials, bearing design, machine reliability and application know-how, these solutions can help you achieve new possibilities in machine performance, bearing service life, productivity and cost control.

## Introduction to dry lubricant(s)

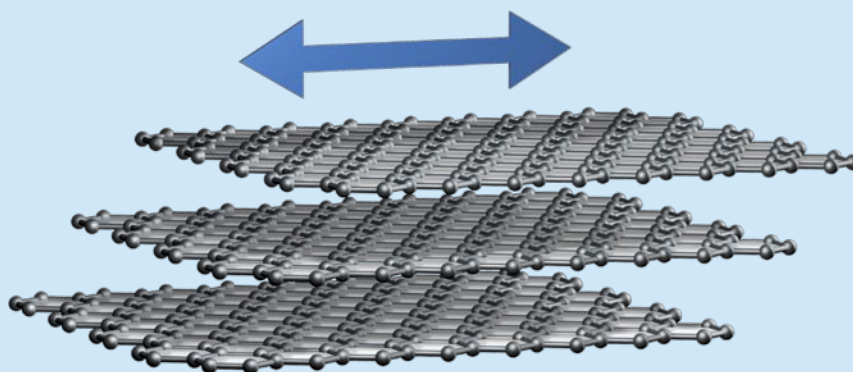

Graphite orients in a lamella structure under load. The weak binding forces between the layers result in very low shear forces and friction in the bearing during operation.

The assortment of dry lubricated bearings from SKF constitutes SKF DryLube bearings and extreme temperature bearings.

These bearings are dry lubricated with graphite and molybdenum disulfide, where the lubricating properties are the result of the formation of a lamella layer structure that is created under load, when the lubricant adheres to the contact surfaces in the bearing.

The binding forces are much stronger within the layers than the van der Waals forces acting between the layers. Therefore, when used in bearings, the layers shear relative to each other resulting in very low friction in the bearing during operation.

The lubricating properties of graphite are further enhanced in the presence of vapour, as the vapour introduced between the graphite layers reduces shear forces and friction.

Molybdenum disulfide does not show the same lubricating characteristics in the presence of vapour and is preferred for extremely dry operating conditions. The lubricant in SKF DryLube bearings contains both graphite and molybdenum disulfide.

The graphite-based lubricant in SKF DryLube bearings is effective at temperatures up to 350 °C (660°F).

To further increase the speed rating and extend bearing service life, SKF DryLube bearings can be supplied with perfluoro polyether (PFPE) oil additives and nanoparticles. These additives further enhance the performance of the bearing.

# SKF DryLube bearings

SKF DryLube bearings are designed to reduce machine operating costs, extend maintenance intervals and provide a high degree of operational reliability even in extremely high temperature applications. SKF DryLube bearings are filled with a dry lubricant, based on graphite, molybdenum disulfide ( $\text{MoS}_2$ ) and a resin binder. The dry lubricant is injected into the free space of the bearing and cured until it solidifies (→ **figs. 1 and 2**). The dry lubricant can protect the rolling elements and raceways from damage caused by solid contaminants.

During operation, a very thin layer of dry lubricant is maintained on the raceways and rolling elements to avoid metal-to-metal contact. After a while, small fragments of solid lubricant may break free and temporarily increase noise and vibration levels. This does not affect the performance or service life of the bearing.

## SKF DryLube bearings provide the following benefits:

- effective lubrication for high temperature applications
- low start-up torque at any temperature and low frictional moment during operation
- higher speed capabilities than extreme temperatures bearings with a graphite cage
- lubricated for the life of the bearing
- minimal lubricant loss
- suitable for extremely slow rotating speeds and oscillating movements
- improved worker safety
- environmentally friendly compared to many oils and greases



SKF E-design spherical roller bearings with two dry lubricant executions. The larger bearing has its entire free space filled with dry lubricant. The smaller bearing has lubricant between the inner ring and cage only.



SKF spherical roller bearing with dry lubricant encapsulated between inner ring and cage



SKF DryLube deep groove ball bearing with manganese phosphate coating to enhance corrosion protection

### Assortment

Most SKF rolling bearings, bearing units and full complement bearings with an internal clearance greater than Normal can be supplied as SKF DryLube bearings. Bearings fitted with a cage must have a metal cage.

The assortment of SKF DryLube bearings mentioned in this catalogue includes:

- deep groove ball bearings
- Y-bearings (insert bearings)
- angular contact ball bearings
- self-aligning ball bearings
- cylindrical roller bearings
- tapered roller bearings
- spherical roller bearings
- thrust ball bearings
- spherical roller thrust bearings

For additional information about spherical plain bearings, bushings or customized units equipped with dry lubricant, contact the SKF application engineering service.



*Most SKF rolling bearings and bearing units can be supplied as SKF DryLube bearings*



## Typical applications

Typical applications where SKF DryLube bearings can be used include:

- metal industry (rolls in bloom and billet casters, cooling beds, roll out tables, guide rolls in bar mills, reheating furnace rolls)
- industrial ovens (kiln truck wheel bearings and bearings for hardening and annealing ovens)
- food and beverage industry (ovens, smokehouse conveyor lines, wafer ovens, sterilization equipment)
- paint lines for automotive and powder coating
- paper industry (paper converting lines, packaging and printing, rope sheaves)

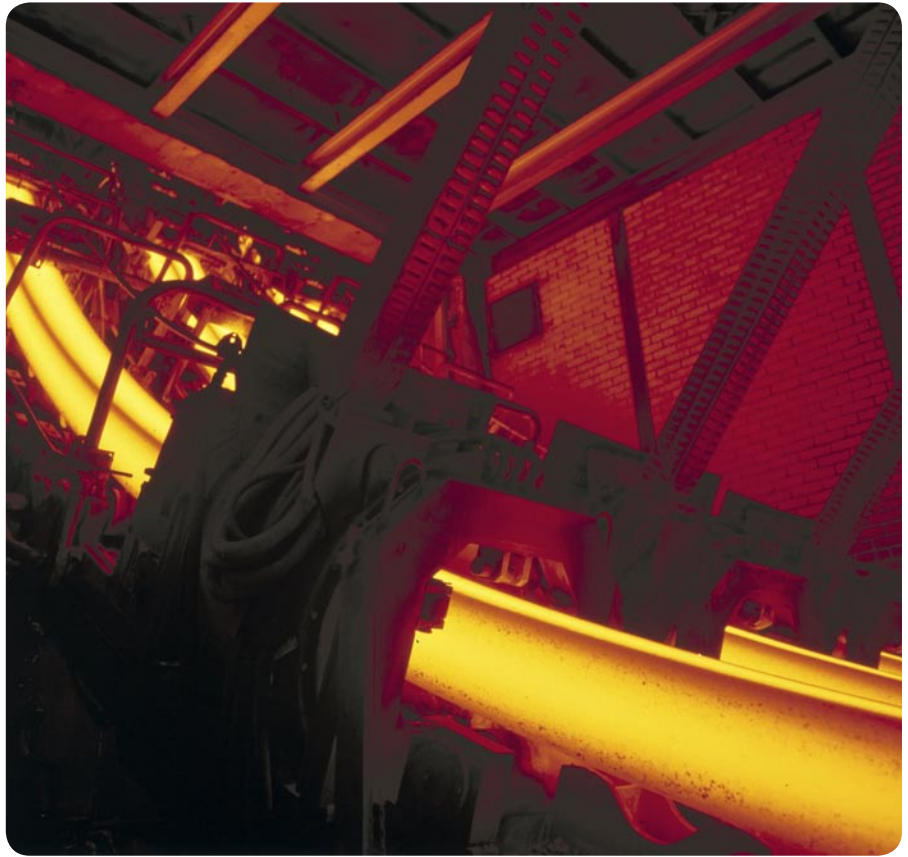

*SKF DryLube bearings in the metal industry. Spherical roller bearings or deep groove ball bearings in rolls of continuous casters.*

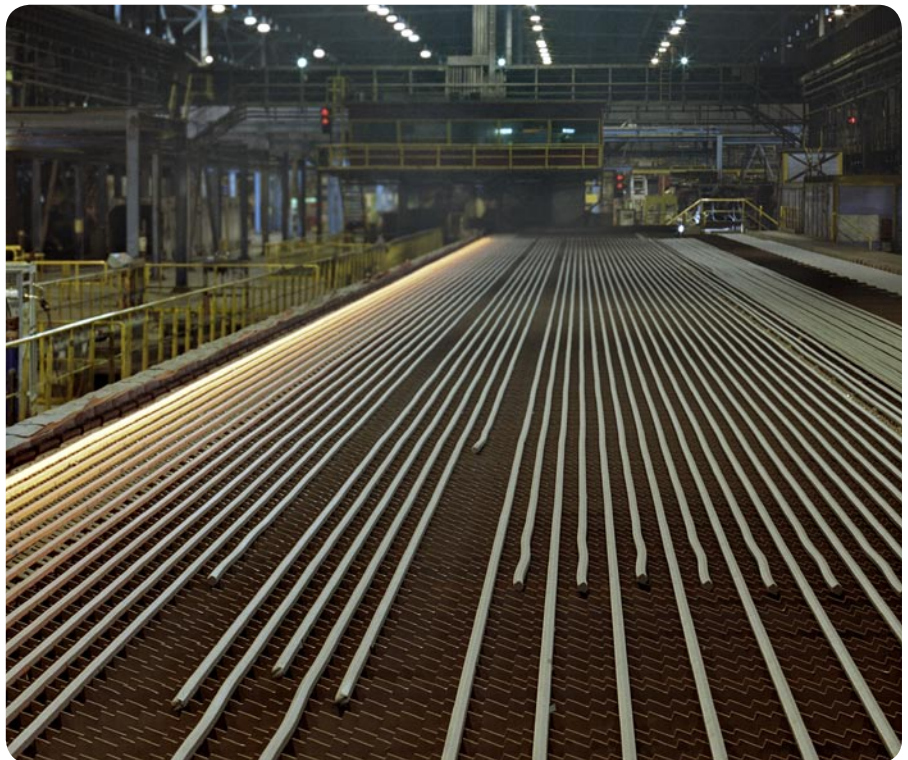

*SKF DryLube bearings in the metal industry. Spherical plain bearings and roller bearings units in cooling beds in bar mills.*





*SKF DryLube bearings in the food and beverage industry. Spherical roller bearings in rollers of continuous biscuit ovens.*



*SKF DryLube bearings in the paper industry. Deep groove ball bearings and angular contact ball bearings in rope sheaves in paper machines.*



*SKF DryLube bearings in the metal industry. Deep groove ball bearings in supporting rollers for cooling bed in hot rolling mill.*



*SKF DryLube bearings in the metal industry. Spherical roller bearings and spherical plain bearings in walking beam mechanism and in rollers outside of reheating furnaces.*



*SKF DryLube bearings in general industry. Deep groove ball bearings in overhead conveyors in powder coating lines.*



*SKF DryLube bearings in the metal industry. Spherical roller bearings in roll-out tables of continuous caster.*

## Designs and variants

SKF DryLube bearings are available in three main variants based on the operating conditions of the application (→ **table 1**). The bearings are filled with a dry lubricant based on graphite and molybdenum disulfide. To further increase speed capabilities and extend bearing service life, nanoparticles and PFPE-oil additives are also available (→ **table 1**).

Some sizes of deep groove ball bearings and Y-bearings are available with a manganese phosphate coating on the bearing rings, rolling elements and cages to enhance adhesion of the dry lubricant to the metal and provide additional protection against corrosion (→ **fig. 3**).

## Temperature limits

At temperatures above 250 °C (480 °F), the resin binder begins to degrade. This does not have an effect on the effectiveness of the lubricant. However, for continuous operation at temperatures above 250 °C (480 °F), SKF recommends using bearings with a shield on both sides (designation suffix 2Z), or bearing arrangements with Nilos rings (→ **fig. 4**) to keep the lubricant in the bearing. Bearings with dry lubricant only between the inner ring (or the shaft washer) and cage (→ *Bearing data*) may work at elevated temperatures without shields.

The recommended temperature limits are listed in **table 1**.

## Maintenance

SKF DryLube bearings are lubricated for the life of the bearing.

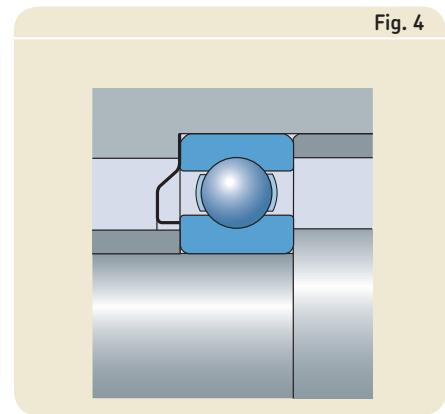

Table 1

### Characteristics of SKF DryLube bearings

	Variant					
	VA260	VA210	VA261	VA2101	VA267	VA237
<b>Phosphated rings, rolling elements and cages<sup>1)</sup></b>	Yes	–	Yes	–	Yes	–
<b>Lubrication</b>						
Graphite-based lubricant	Yes	–	Yes	–	Yes	–
Perfluoro polyether (PFPE) oil additive	–	–	Yes	–	Yes	–
Nanoparticles	–	–	–	–	Yes	–
NSF H1 food grade	Yes	–	–	–	–	–
Dry lubricant only	Yes	–	–	–	–	–
<b>Operating temperature</b>						
Minimum	–60 °C (–75 °F)	–	–60 °C (–75 °F)	–	–60 °C (–75 °F)	–
Maximum						
• open bearings	250 °C (480 °F)	–	250 °C (480 °F)	–	250 °C (480 °F)	–
• bearings with a shield on both sides (designation suffix 2Z) <sup>2)</sup>	350 °C (660 °F)	–	350 °C (660 °F)	–	350 °C (660 °F)	–
<b>Limiting speed [r/min]</b>						
• Radial ball bearings	$\frac{15\,000}{d_m}$	–	$\frac{60\,000}{d_m}$	–	$\frac{120\,000}{d_m}$	–
• Radial roller bearings	$\frac{7\,500}{d_m}$	–	$\frac{30\,000}{d_m}$	–	$\frac{60\,000}{d_m}$	–
• Thrust bearings	$\frac{3\,750}{d_m}$	–	$\frac{15\,000}{d_m}$	–	$\frac{30\,000}{d_m}$	–







$d_m$  = bearing mean diameter [mm] = 0,5 (d + D)

<sup>1)</sup> Available only for certain series and sizes of deep groove ball bearings and Y-bearings.

<sup>2)</sup> Also applicable for bearings with dry lubricant only between the inner ring (or the shaft washer) and cage (→ *Bearing data*) or bearing arrangements with Nilos rings (→ **fig. 4**).

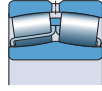
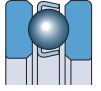

# Bearing data

	Deep groove ball bearings	Y-bearings	Angular contact ball bearings	Cylindrical roller bearings	Tapered roller bearings	Spherical roller bearings	Thrust ball bearings	Spherical roller thrust bearings
								
<b>Dimension standards</b>	Refer to the product chapter of the relevant standard bearing. <sup>1)</sup>							
<b>Surfaces of rings, rolling elements and cages manganese phosphated</b>	Optional		–					
<b>Tolerances</b>	Refer to the product chapter of the relevant standard bearing. <sup>1)</sup> There may be slight deviations for phosphated bearings from the standard tolerances. These deviations do not have an influence on mounting or bearing operation.							
<b>Radial internal clearance</b>	Multiples of C5 (→ table 6, page 17) Check availability for C3, C4 or C5  Guidelines for the initial clearance: (→ diagram 1, page 10)	Twice C5 of deep groove ball bearings (→ table 6, page 17)	–	C3, C4, C5  Guidelines for the initial clearance: (→ diagram 2, page 10)	–	C3, C4, C5  Guidelines for the initial clearance: (→ diagram 3, page 10)	–	–
<b>Stabilization</b>	120 °C (250 °F)	120 °C (250 °F)	120 °C (250 °F)	150 °C (300 °F)	120 °C (250 °F)	200 °C (390 °F)	120 °C (250 °F)	200 °C (390 °F)
	The rings, rolling elements and cages of SKF DryLube bearings undergo the same heat stabilization process as the relevant standard bearing. As a result, for higher operating temperatures, a certain amount of dimensional change is to be expected and must be taken into account when determining the initial internal clearance of the bearing. For high-speed applications operating at very high temperatures, special stabilization of the bearing rings may be necessary. For additional information, contact the SKF application engineering service.							
<b>Misalignment</b>	Refer to the product chapter of the relevant standard bearing. <sup>1)</sup>							
<b>Filling grade of dry lubricant</b>	Entire free space in the bearing				Free space between the inner ring and cage	<ul style="list-style-type: none"> <li>• CC design and E design (d ≤ 65 mm): free space between the inner ring and cage</li> <li>• Other bearings: entire free space in the bearing</li> </ul>	<ul style="list-style-type: none"> <li>• 511 series (d ≥ 90 mm) and 514 series (d ≥ 50 mm): entire free space in the bearing</li> <li>• Other bearings: free space between the shaft washer and cage</li> </ul>	Free space between the shaft washer and cage

<sup>1)</sup> Consult [www.skf.com/bearings](http://www.skf.com/bearings) for additional information

# Speed limits

The limiting speed for the different variants of SKF DryLube bearings can be calculated using the formulas listed in **table 1, page 8**. **Diagram 4** provides estimated values. If the bearing clearance is greater than C3, the limiting speed should be reduced according to **diagrams 1 to 3**.

Diagram 1

### Selection guidelines for initial clearance of SKF DryLube deep groove ball bearings

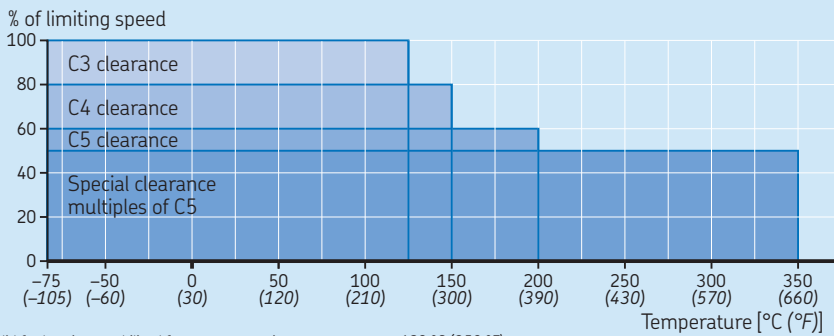

Valid for bearings stabilized for use at operating temperatures  $\leq 120$  °C (250 °F).

Diagram 2

### Selection guidelines for initial clearance of SKF DryLube cylindrical roller bearings

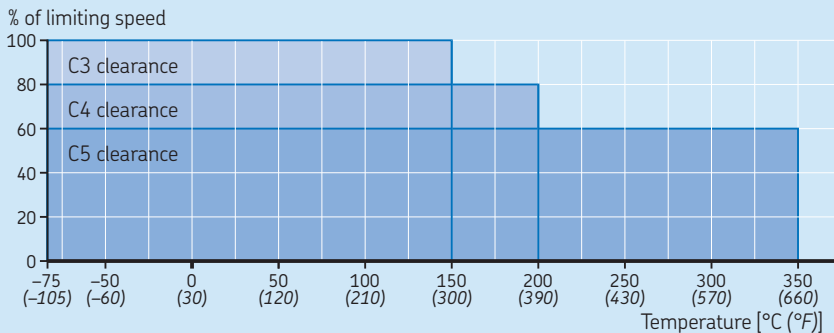

Valid for bearings, stabilized for use at operating temperatures  $\leq 150$  °C (300 °F).

Diagram 3

### Selection guidelines for initial clearance of SKF DryLube spherical roller bearings

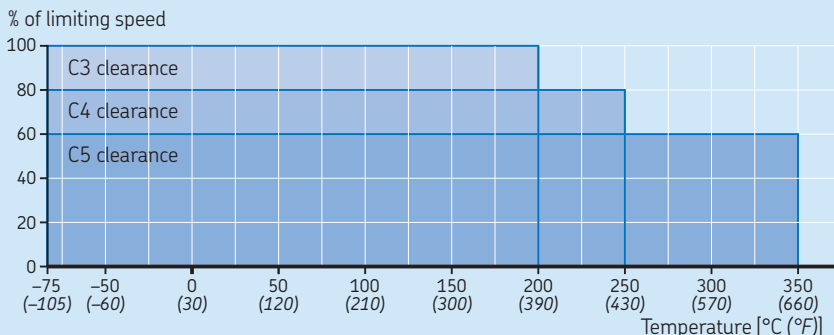

Valid for bearings, stabilized for use at operating temperatures  $\leq 200$  °C (390 °F).

Diagram 4

### Guidelines for limiting speed of SKF DryLube radial ball bearings

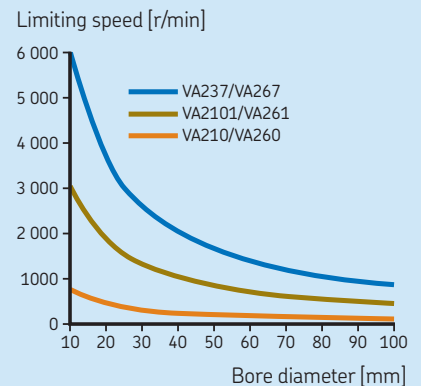

For thrust bearings, 25% of the limiting speed is permissible. For radial roller bearings, 50% of the limiting speed is permissible.

### ! WARNING!

Safety precautions for bearings with PFPE based oil additives. PFPE oil is very stable and harmless under normal operating conditions up to +250 °C (480 °F). However, if exposed to extreme temperatures such as those above 300 °C (570 °F), PFPE oils give off hazardous fumes. These fumes can be harmful to the eyes and to the lungs, if inhaled.

The following safety precautions should be observed:

- Follow the safety precautions in the appropriate material safety data sheet (MSDS).
- If there is a risk of human exposure and the bearing operating temperature is above 300 °C, appropriate ventilation is required.

If the fumes have been inhaled, consult a doctor immediately.

The user is responsible for the correct use of the product during its service life and its proper disposal. SKF takes no responsibility for the improper handling of bearings with PFPE oil additives or for any injury resulting from their use.

# Extreme temperature bearings

## Deep groove ball bearings and Y-bearings with a graphite cage or graphite paste

Extreme temperature bearings are designed to reduce machine operating costs, extend maintenance intervals and provide a high degree of operational reliability even in extremely high temperature applications. The SKF assortment of extreme temperature bearings includes:

- deep groove ball bearings (→ **fig. 1, page 13**)
- Y-bearings (insert bearings) (→ **fig. 2, page 13**)
- Y-bearing units (→ [www.skf.com/bearings](http://www.skf.com/bearings))

Extreme temperature bearings listed in this catalogue constitute the basic SKF assortment. On request, SKF can supply other extreme temperature bearings to meet the needs of a particular application. For information about these engineered products, contact the SKF application engineering service.

SKF extreme temperature bearings provide the following benefits:

- effective lubrication for extreme temperature applications
- lubricated for the life of the bearing
- minimal lubricant loss over the life of the bearing
- suitable for slow and extremely slow speeds
- improved worker safety and environmentally friendly compared to many oils and greases
- efficient lubricant even at the upper temperature limit of 350 °C (660 °F)





## Typical applications

Typical applications where SKF extreme temperature bearings are used include:

- metal industry (cooling beds)
- industrial ovens (kiln truck wheel bearings and chain bearings for hardening and annealing ovens)
- food and beverage industry (baking ovens, wafer ovens, sterilization equipment)
- paint lines for automotive and powder coating



*SKF extreme temperature bearings in general industry. Y-bearings supporting rolls of annealing ovens.*



*SKF extreme temperature bearings in the building material industry. Deep groove ball bearings in wheels of kiln trucks.*

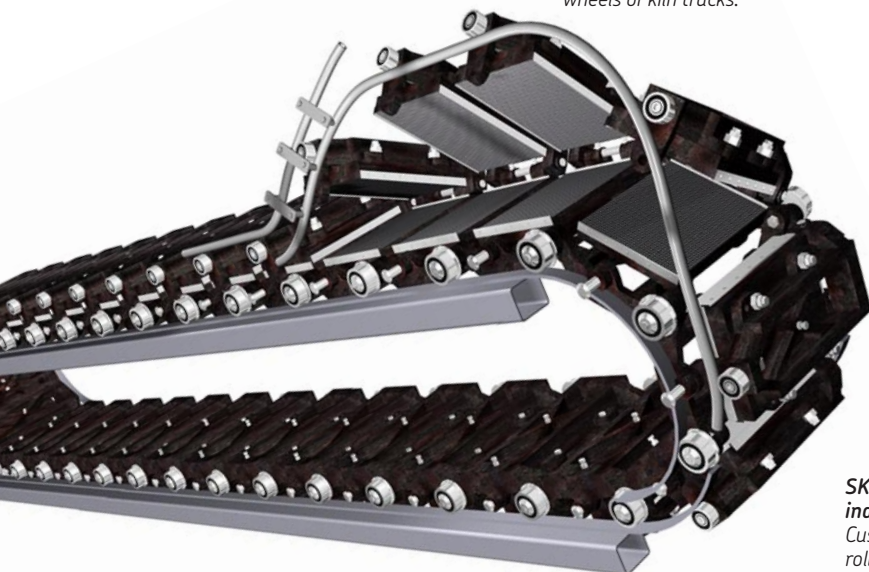

*SKF extreme temperature bearings in the food and beverage industry. Customized extreme temperature bearings in carrier wheels and top rollers in continuous wafer ovens.*

## Extreme temperature deep groove ball bearings

SKF extreme temperature deep groove ball bearings correspond in design to standard deep groove ball bearings of the same size. They have no filling slots and can accommodate axial loads in addition to radial loads. The radial internal clearance is a multiple of C5 to maintain bearing operating clearance even when operating at maximum operating temperature. All surfaces of the bearing and shields are manganese phosphated to enhance adhesion of the dry lubricant to the metal and provide additional protection against corrosion.

SKF extreme temperature deep groove ball bearings are available in the variants listed in **table 1**. The bearings have a shield on both sides (designation suffix 2Z). The VA201 variant is also available as an open bearing (→ **fig. 1**).

Shields prevent the ingress of solid contaminants into the bearing.

## Extreme temperature Y-bearings

SKF extreme temperature Y-bearings (insert bearings) correspond in design to standard Y-bearings with grub screws in the YAR 2-2F series. The bearings have a shield and a flinger on both sides to prevent the ingress of solid contaminants into the bearing. The radial internal clearance is twice the C5 clearance of same-size deep groove ball bearings. All surfaces of the bearing and shields are manganese phosphated to enhance adhesion of the dry lubricant to the metal and provide additional protection against corrosion.

SKF extreme temperature Y-bearings are available in the VA201 and VA228 variants (→ **fig. 2**).

Fig. 1

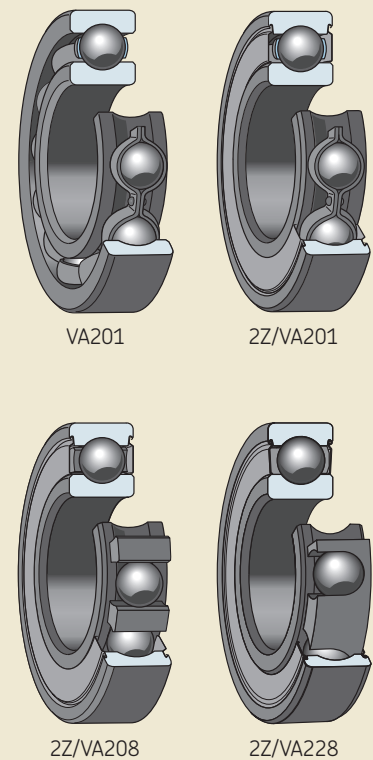

Fig. 2

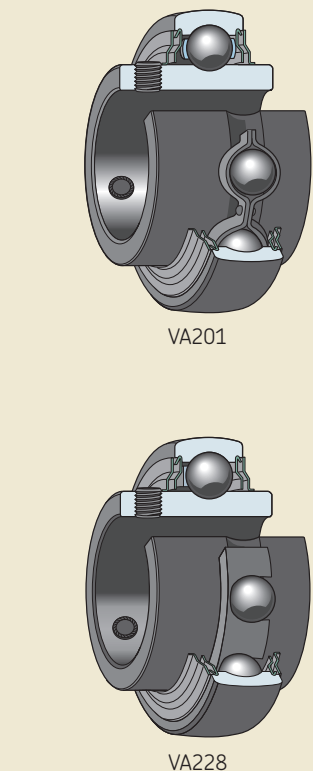

Table 1  
Extreme temperature variants for deep groove ball bearings and Y-bearings

Available types:	VA201 Y-bearings/deep groove ball bearings	VA208 deep groove ball bearings	VA228 Y-bearings/deep groove ball bearings
<b>Characteristics</b>	<ul style="list-style-type: none"> <li>Bearing with a riveted steel cage</li> <li>Filled with a polyalkylene glycol/graphite mixture for lubrication</li> </ul>	<ul style="list-style-type: none"> <li>Bearing with a segmented cage made of graphite</li> <li>A shield on both sides of the bearing guides the cage segments.</li> <li>Even at the upper temperature limits, the segmented graphite cage will not release harmful vapours.</li> <li>Should not be used for applications where the direction of rotation changes frequently.</li> </ul>	<ul style="list-style-type: none"> <li>Bearing with a coronet cage made of graphite</li> <li>A shield on both sides of the bearing guides the cage.</li> <li>Even at the upper temperature limits, the graphite cage will not release harmful vapours.</li> </ul>
<b>Operating temperature</b>			
Minimum	-30 °C (-20 °F) <sup>1)</sup>	-60 °C (-75 °F)	-60 °C (-75 °F)
Maximum	250 °C (480 °F)	350 °C (660 °F)	350 °C (660 °F)
<b>Limiting speed</b> [r/min]	$\frac{9\,000}{d_m}$	$\frac{4\,500}{d_m}$	$\frac{9\,000}{d_m}$

$d_m$  = bearing mean diameter [mm] = 0,5 (d + D)

<sup>1)</sup> VA201 bearings operating below 200 °C (390 °F) at speeds below 25% of limiting speed require a running-in procedure. These bearings should be heated to 200 °C (390 °F) for at least 48 hours.

# Maintenance

Extreme temperature bearings with a shield on both sides do not have a relubrication facility as they are lubricated for the life of the bearing.

Open VA201 design deep groove ball bearings should be inspected after some six months of operation. These can be relubricated with a polyalkylene glycol/graphite mixture. For additional information, contact the SKF application engineering service.

## Bearing data

	Extreme temperature deep groove ball bearings	Extreme temperature Y-bearings
<b>Dimension standards</b>	Boundary dimensions: ISO 15:1998	Boundary dimensions: ISO 9628:2006
<b>Tolerances</b>	Normal Values: ISO 492:2002	Normal, except the bore and outside diameter Values: ISO 492:2002 Values for the bore and outside diameter (→ table 5, page 17)
	Due to the special surface treatment of the bearings, there may be slight deviations from the standard tolerances. These deviations do not have an influence on mounting or bearing operation.	
<b>Internal clearance</b>	Multiples of C5	Twice C5 of deep groove ball bearings in accordance with ISO 5753-1:2009
	Values (→ table 6, page 17) are valid for unmounted bearings under zero measuring load.	
<b>Misalignment</b>	≈ 20 to 30 minutes of arc	
	The above values apply only when the bearings rotate slowly. The permissible angular misalignment between the inner and outer ring depends on the size and internal design of the bearing, radial internal clearance in operation and the forces and moments acting on the bearing. As a result, only approximate values are listed here. Any misalignment will increase bearing noise and reduce bearing service life.	



SKF extreme temperature Y-bearings showing SY-, FY- and FYT Y-bearing units. Dimensions and assortment of Y-bearing units → [www.skf.com/bearings](http://www.skf.com/bearings)



# Principles of bearing selection and applications

## Design of bearing arrangements

SKF DryLube bearings and extreme temperature bearings can be mounted with a loose or an interference fit on the shaft and in the housing. However, either the inner or outer ring should be mounted with an interference fit, to locate the shaft and provide satisfactory support (→ **table 1**).

## Mounting

Mounting with mechanical force might crack the dry lubricant. Therefore, SKF DryLube bearings and the extreme temperature bearings should always be hot mounted to reduce the mounting force.

For additional information, refer to [skf.com/mount](http://skf.com/mount).

## Y-bearing arrangement

### Axial displacement

Y-bearing units do not accommodate axial displacement of the shaft and are therefore not normally suitable for non-locating bearing (free unit) arrangements. The distance between bearing positions should therefore be short or the units should be supported by resilient sheet metal support surfaces or walls to prevent them from being subjected to excessive stresses as a result of thermal elongation of the shaft.

In applications where there are low speeds, light loads, the distance between the bearing positions is too long or the operating temperatures too high and one bearing position has to accommodate thermal elongation of the shaft, the following arrangement is recommended.

The shaft on the non-locating side should be provided with one or two grooves 120° apart, to engage one of the following:

- grub screws with a finger, e.g. in accordance with ISO 4028:2003, but with a fine thread according to **table 2**, secured by a nut and spring washer or star lock washer (→ **fig. 1**)
- flat head screws in accordance with ISO 1580:1994, but with a fine thread according to **table 2**, locked with a spring or star lock washer

The fingers and grooves accommodate changes in shaft length and prevent relative rotational movements between the shaft and bearing bore. To help provide trouble-free operation, the ends of the grub screws should be ground and the sliding surfaces in the shaft grooves coated with a lubricant paste.

### Shaft tolerances

For moderate loads ( $0,035 C < P \leq 0,05 C$ ), the shaft seats for Y-bearings should be machined to an h7 tolerance. For light loads and low speeds, an h8 shaft tolerance is sufficient.

## Mounting

To mount or dismount Y-bearing units, the following tools are required:

- a hexagonal key (hex wrench) to tighten or loosen grub (set) screws (→ **table 2**)
- a spanner or hexagonal key to tighten or loosen the fasteners

For additional mounting information, refer to [skf.com/mount](http://skf.com/mount).

Table 1

Fits for SKF Dry lubricated bearings on solid steel shafts or in cast iron and steel housings

Load condition	Tolerance class
<b>Rotating inner ring load</b>	
Shaft diameter	k5 <sup>1)</sup>
Housing bore	F7
<b>Stationary inner ring load</b>	
Shaft diameter	g6
Housing bore	J7

<sup>1)</sup> For d > 100 mm, contact the SKF application engineering service.

Table 2

Grub screw hexagonal socket dimensions and tightening torques

Bearing bore	Threaded holes	Hexagonal key size	Tightening torque
over	incl.		
mm/in.		mm/in.	Nm
<b>For metric shafts</b>			
	35	M 6 × 0,75	3
	45	M 8 × 1	4
	65	M 10 × 1	5
	75	M 10 × 1	6
<b>For inch shafts</b>			
	1 3/16	5/16 - 24 UNF	3/8
	1 3/4	5/16 - 24 UNF	5/32
	1 3/4	7/16 - 24 UNF	3/16
	2 7/16	7/16 - 20 UNF	7/32

Fig. 1

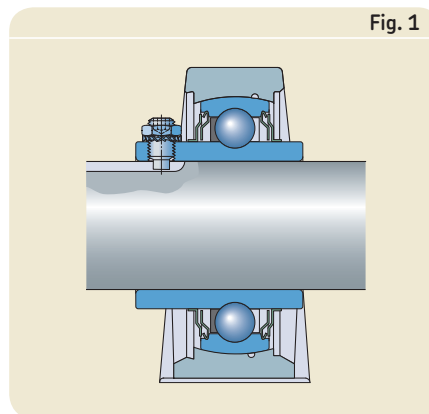

## Selection of bearing size

The requisite bearing size for rotating bearings can be determined based on the basic dynamic load rating C. The corresponding standard bearing should have a C value  $\geq$  the requisite value.

However, the basic static load rating  $C_0$  is used when the bearings are to:

- rotate at very slow speeds ( $n < 10$  r/min)
- perform very slow oscillating movements
- be stationary under load for extended periods
- generally used for extreme temperature bearings (suffixes VA201, VA208 and VA228)

The corresponding standard bearing should have a  $C_0$  value  $\geq$  the requisite value. C and  $C_0$  values for deep groove ball bearings and Y-bearings are available on **pages 22 to 24**. For other bearing types consult [www.skf.com/bearings](http://www.skf.com/bearings).

Calculating the requisite basic dynamic load rating	Calculating the requisite basic static load rating	Symbols
$C_{req} = S_{req} P / f_T$	$C_{0 req} = 2 P_0 / f_T$	$C_{req}$ = requisite basic dynamic load rating [kN] $C_{0 req}$ = requisite basic static load rating [kN] $F_a$ = axial load [kN] $F_r$ = radial load [kN] $f_T$ = temperature factor ( $\rightarrow$ <b>table 3</b> ) $P$ = equivalent dynamic bearing load [kN] $P_0$ = equivalent static bearing load [kN] $S_{req}$ = guideline value for dynamic load safety factor ( $\rightarrow$ <b>table 4</b> )
For calculating P, refer to the product chapter of the relevant standard bearing.	For calculating $P_0$ , refer to the product chapter of the relevant standard bearing.	
$P = F_r$ when $P < F_r$	$P_0 = F_r$ when $P_0 < F_r$	
For deep groove ball bearings, $F_a$ should not exceed $0,15 C_0$		

## Dry lubricated bearings to be kept dry

Since dry lubricated bearings are supplied without preservative oils and are to be used without grease or oil lubrication the anti-corrosion properties of the bearings is limited. Therefore the bearings should be used in a dry environment or with proper sealing arrangement to keep the bearings dry.

Table 3

### Operating temperature factor $f_T$

		$f_T$
$^{\circ}\text{C}$	$^{\circ}\text{F}$	–
150	300	1
200	390	0,9
250	480	0,75
300	570	0,6
350	660	0,45

Table 4

### Guideline values for dynamic load safety factor $S_{req}$

#### Application

$S_{req}$

**Machines used for short periods or intermittently:**  
cooling beds, guide rollers

3

**Machines used for short periods or intermittently where high operational reliability is required:**  
cranes in metals applications

5

**Machines in use 8 hours per day and fully utilized:**  
conveyor belts, hardening and annealing ovens

10

**Machines in use 24 hours per day:**  
conveyor systems, equipment in continuous casting mills

12

**Example 1**

A kiln truck is equipped with four wheels fitted on stub axles (→ **fig. 2**). Each wheel has two identical bearings. The bearings are to operate intermittently at 2 r/min under a constant radial load  $F_r = 15$  kN per bearing. Flange load is neglected in this example. The kiln truck passes through an oven with a maximum operating temperature  $T = 300$  °C (570 °F). What would be a suitable SKF extreme temperature bearing for this application?

The slow speed (2 r/min) implies that the bearing static load capacity should be used to select the bearing. The requisite basic static load rating  $C_0$  is

$$C_{0 \text{ req}} = 2 \frac{P_0}{f_T}$$

- From **table 3**, for  $T = 300$  °C (570 °F),  $f_T = 0,6$
- Since the load is purely radial,  $P_0 = F_r = 15$  kN

$$C_{0 \text{ req}} = 2 \frac{15}{0,6} = 50 \text{ kN}$$

Thus, a bearing having a static load rating  $C_0$  of at least 50 kN is required. For example, bearing **6216-2Z/VA208** (→ **product table, page 23**) is suitable ( $C_0 = 55$  kN).

**Example 2**

A guide roll is equipped with two deep groove ball bearings. The guide rolls operate 24 h/day at 1 500 r/min under a radial load  $F_r = 2$  kN per bearing. The operating temperature  $T = 150$  °C (300 °F). What would be a suitable SKF DryLube bearing?

The requisite basic dynamic load rating is

$$C_{\text{req}} = S_{\text{req}} \frac{P}{f_T}$$

- From **table 4**, for 24 h/day operation, the dynamic load safety factor  $S_{\text{req}} = 12$
- From **table 3**, for  $T = 150$ °C (300 °F),  $f_T = 1$
- Since the load is purely radial,  $P = F_r = 2$  kN

$$C_{\text{req}} = 12 \frac{2}{1} = 24 \text{ kN}$$

Thus, a bearing having a dynamic load rating C of at least 24 kN is required. For example, bearing **6207** is suitable ( $C = 27$  kN).

Requisite initial clearance needs to be verified.

- From **diagram 1, page 10**, for  $T = 150$  °C (300 °F), C4 clearance is required.

The speed capability of the bearing needs to be verified.

- The appropriate variant of SKF DryLube bearing is selected based on the bearing speed, using the rotational speed and bearing mean diameter.
- From the product table for bearing **6207**,  $d_m = 0,5 (d + D) = 0,5 (35 + 72) = 53,5$  mm.
- From **diagram 1, page 10**, limiting speed should be reduced to 80% for C4 clearance bearings.

$$n_{\text{dm limiting}} = \frac{n_{\text{dm}}}{\text{reduction factor}} = \frac{1\ 500 \times 53,5}{0,8} = 100\ 312 \text{ mm/min}$$

where

$n_{\text{dm limiting}}$  = limiting speed factor, mm/min (→ **table 1, page 8**)

Therefore, **VA237** variant should be selected ( $n_{\text{dm limiting}} = 120\ 000$  mm/min).

Consequently, bearing **6207-2Z/C4VA237** is suitable.

**Fig. 2**

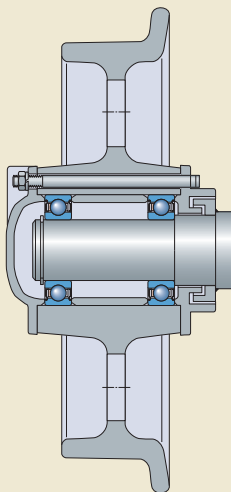

**Table 5**

**Tolerances of dry lubricated Y-bearings**

Nominal diameter d, D over incl.	Bore diameter <sup>1)</sup> Deviation high low	Outside diameter Deviation high low	
		mm	µm
18	30	+18	0
30	50	+21	0
50	80	+24	0
80	120	+28	0

<sup>1)</sup> Values in accordance with ISO 9628:2006

**Table 6**

**Radial internal clearance of dry lubricated bearings**

Bore diameter d over incl.	Radial internal clearance				
	Deep groove ball bearings		Y-bearings		
mm	µm	min	max	min	max
10	18	40	136	–	–
18	24	56	172	56	96
24	30	60	192	60	106
30	40	80	236	80	128
40	50	90	272	90	146
50	65	110	340	110	180
65	80	130	400	–	–
80	120	150	460	–	–



Selection guidelines for SKF DryLube bearings and extreme temperature bearings

Product group	Suffix	Phosphated rings, rolling elements and cage	Speed	High temp	Low temp	Low friction	Oscillation	Vibration	
SKF DryLube bearings	VA210 VA260	– Yes	Graphite-based lubricant	++	+++	++	++++	+++	+
	VA2101 VA261	– Yes	Graphite-based lubricant and PFPE-oil additive	+++	+++	+	+++	+++	+
	VA237 VA267	– Yes	Graphite-based lubricant, PFPE-oil additive and nanoparticles	++++	+++	+	+++	+++	+
Extreme temperature bearings	VA201	Yes	Steel cage, lubricated with a polyalkylene glycol/graphite mixture	+	++	–	+	+	++
	VA208	Yes	Segmented cage made of graphite	0	++++	++	0	–	–
	VA228	Yes	Coronet cage made of graphite	+	++++	++	+	+	–

- Unsuitable
- 0 Moderate
- + Suitable
- ++ Recommended
- +++ Highly suitable
- ++++ Excellent

Diagram 1

Limiting speed for SKF dry lubricated radial ball bearings

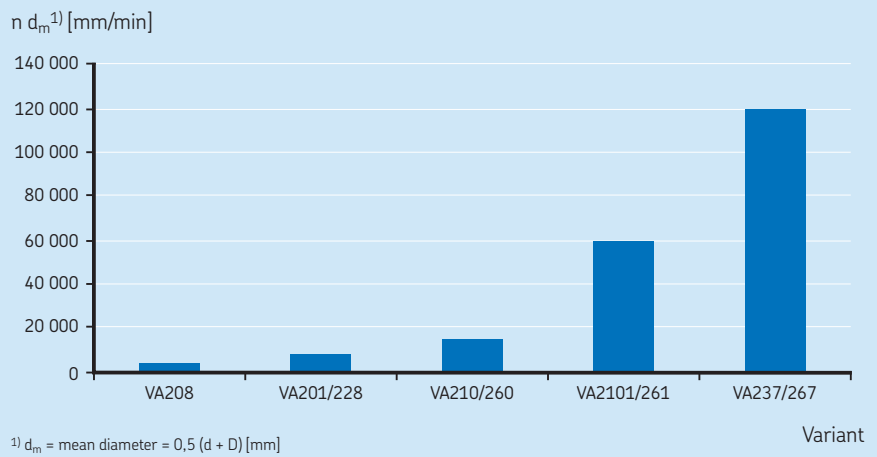

## Bearing designation system

				Group 1	Group 2	Group 3	/	Group 4					
								4.1	4.2	4.3	4.4	4.5	4.6
<b>Designation example</b>													
22208 E/C4VA2101													
W 6208-2Z/C4VA210													
6210-2Z/VA260													
<b>Prefix</b>													
W Stainless steel deep groove ball bearings													
BS2 Spherical roller bearings with two rows of rollers non standard													
<b>Basic designation</b>													
<b>Bore diameter</b>													
00 10 mm bore diameter													
01 12 mm bore diameter													
02 15 mm bore diameter													
03 17 mm bore diameter													
04 20 mm bore diameter													
to denotes bore diameter divided by 5													
96 480 mm bore diameter													
<b>Suffixes</b>													
<b>Group 1: Internal design</b>													
K Tapered bore, taper 1:12													
<b>Group 2: External design (seals, snap ring groove etc.)</b>													
2Z Open bearing execution													
Z shield on both sides of the bearing													
2CS2 Contact seals of fluoro rubber (FKM) on both sides of the bearing													
2CS5 Sheet steel reinforced contact seal of hydrogenated acrylonitrile-butadiene rubber (HNBR) on both sides of the bearing													
<b>Group 4.2: Clearance, preload</b>													
C3 Special clearance (multiples of C5) (applicable for deep groove ball bearings and Y-bearings only)													
C4 Bearing internal clearance greater than normal (CN)													
C5 Bearing internal clearance greater than C3													
<b>Group 4.4: Stabilization</b>													
S0 Standard stabilization for base bearing (→ <i>Bearing data</i> , page 9)													
S1 Bearing rings dimensionally stabilized for use at operating temperatures up to +150°C (+300°F)													
S2 Bearing rings dimensionally stabilized for use at operating temperatures up to +200°C (+390°F)													
S3 Bearing rings dimensionally stabilized for use at operating temperatures up to +250°C (+480°F)													
<b>Group 4.6: Other variants</b>													
VA201 Extreme temperature bearings with a steel cage, lubricated with a polyalkylene glycol/graphite mixture													
VA208 Extreme temperature bearings with segmented cage made of graphite													
VA228 Extreme temperature bearings with coronet cage made of graphite													
VA260 SKF DryLube bearings with graphite based lubricant + complete bearing phosphated													
VA210 SKF DryLube bearings with graphite based lubricant													
VA261 SKF DryLube bearings with graphite based lubricant + PFPE-oil additive + complete bearing phosphated													
VA2101 SKF DryLube bearings with graphite based lubricant + PFPE-oil additive													
VA267 SKF DryLube bearings with graphite based lubricant + PFPE-oil additive + nanoparticles + complete bearing phosphated													
VA237 SKF DryLube bearings with graphite based lubricant + PFPE-oil additive + nanoparticles													

## Y-bearings designation system

### Designation example

YAR 208-2FW/VA260  
 YAR 210-2FW/C4VA2101  
 YAR 205-100-2FW/VA228

### Bearing series

**YAR 2** Inner ring extended on both sides, with grub screws

### Bore diameter

**04 to 20** **Bearings for metric shafts**  
 20 mm bore diameter

100 mm bore diameter

**-012** **Bearings for inch shafts**  
 Three-digit combination that follows the designation of the basic metric bearing separated by a hyphen; the first digit is the number of whole inches and the second and third digits are the number of sixteenths of an inch, e.g. 204-012

$1\frac{2}{16} = \frac{3}{4}$  of an inch = 19,050 mm bore diameter

1 in. = 25,400 mm bore diameter

**-100 to -208**  $2\frac{8}{16} = 2\frac{1}{2}$  in. = 63,500 mm bore diameter

### Suffixes

#### Group 2: External design (seals)

**2F** Steel shield with an additional plain flinger on both sides of the bearing

**W** Bearing without lubrication hole

#### Group 4.2: Clearance

**C4** Special clearance (multiples of C5)  
 Bearing internal clearance greater than C3

#### Group 4.6: Other variants

**VA201** Extreme temperature bearings with a sheet steel cage, lubricated with a polyalkylene glycol/graphite mixture

**VA228** Extreme temperature bearings with coronet cage made of graphite

**VA260** SKF DryLube bearings with graphite based lubricant + complete bearing phosphated

**VA210** SKF DryLube bearings with graphite based lubricant

**VA261** SKF DryLube bearings with graphite based lubricant + PFPE-oil additive + complete bearing phosphated

**VA2101** SKF DryLube bearings with graphite based lubricant + PFPE-oil additive

**VA267** SKF DryLube bearings with graphite based lubricant + PFPE-oil additive + nanoparticles + complete bearing phosphated

**VA237** SKF DryLube bearings with graphite based lubricant + PFPE-oil additive + nanoparticles

					Group 2	Group 3	/	Group 4					
								4.1	4.2	4.3	4.4	4.5	4.6



## Y-bearing units designation system

### Designation example

FY 40 TF/VA228  
 FY 60 TF/C4VA2101  
 FY 1.1/4 TF/VA228

### Housing type

FY Square flanged housing  
 FYT Oval flanged housing  
 SY Plummer block housing

### Size

**Bearing units for metric shafts:**  
 in millimetres uncoded  
 20 20 mm bore diameter  
 to  
 100 100 mm bore diameter

**Bearing units for inch shafts:** in inches uncoded  
 3/4 3/4 inch bore diameter  
 to  
 2 7/16 2 7/16 inch bore diameter

### Suffixes

### Identification of inserted Y-bearing

TF Y-bearing with grub screw, YAR 2-2FW series

				Group 2	Group 3	/	Group 4					
							4.1	4.2	4.3	4.4	4.5	4.6

### Group 4.6: Other variants

**VA201** Extreme temperature bearings with a sheet steel cage, lubricated with a polyalkylene glycol/graphite mixture  
**VA228** Extreme temperature bearings with coronet cage made of graphite  
**VA260** SKF DryLube bearings with graphite based lubricant + complete bearing phosphated  
**VA210** SKF DryLube bearings with graphite based lubricant  
**VA261** SKF DryLube bearings with graphite based lubricant + PFPE-oil additive + complete bearing phosphated  
**VA2101** SKF DryLube bearings with graphite based lubricant + PFPE-oil additive  
**VA267** SKF DryLube bearings with graphite based lubricant + PFPE-oil additive + nanoparticles + complete bearing phosphated  
**VA237** SKF DryLube bearings with graphite based lubricant + PFPE-oil additive + nanoparticles

B

# Deep groove ball bearings, SKF DryLube bearings and extreme temperature bearings

d 8 – 120 mm

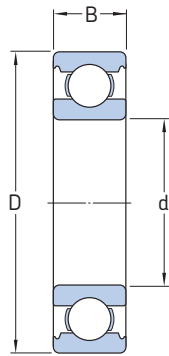

VA201

SKF extreme temperature bearings

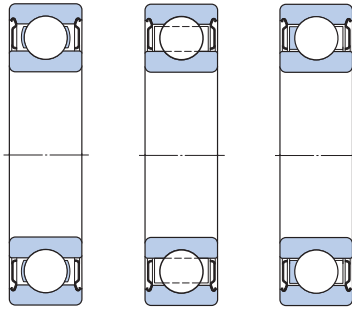

2Z/VA201

2Z/VA208

2Z/VA228

SKF DryLube bearings

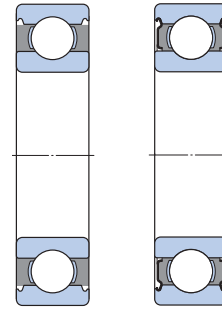

/VA...

2Z/VA...

Principal dimensions			Basic load ratings		Designation Base bearing	Limiting speed				
d	D	B	C	C <sub>0</sub>		Extreme temperature bearings VA208	VA201 VA228	SKF DryLube bearings <sup>1)</sup> VA210 VA260	VA2101 VA261	VA237 VA267
mm			kN			r/min				
<b>8</b>	22	7	3,45	1,37	<b>608</b>	300	600	1 000	4 000	8 000
	24	8	3,9	1,66	<b>628</b>	280	560	940	3 800	7 500
<b>9</b>	24	7	3,9	1,66	<b>609</b>	270	550	910	3 600	7 300
	26	8	4,75	1,96	<b>629</b>	260	510	860	3 400	6 900
<b>10</b>	26	8	4,75	1,96	<b>6000</b>	250	500	830	3 300	6 700
	30	9	5,4	2,36	<b>6200</b>	230	450	750	3 000	6 000
	35	11	8,52	3,4	<b>6300</b>	200	400	670	2 700	5 300
<b>12</b>	28	8	5,4	2,36	<b>6001</b>	230	450	750	3 000	6 000
	32	10	7,28	3,1	<b>6201</b>	200	410	680	2 700	5 500
	37	12	10,1	4,15	<b>6301</b>	180	370	610	2 400	4 900
<b>15</b>	32	9	5,85	2,85	<b>6002</b>	190	380	640	2 600	5 100
	35	11	8,06	3,75	<b>6202</b>	180	360	600	2 400	4 800
	42	13	11,9	5,4	<b>6302</b>	160	320	530	2 100	4 200
<b>17</b>	35	10	6,37	3,25	<b>6003</b>	170	350	580	2 300	4 600
	40	12	9,95	4,75	<b>6203</b>	160	320	530	2 100	4 200
	47	14	14,3	6,55	<b>6303</b>	140	280	470	1 900	3 800
<b>20</b>	42	12	9,95	5	<b>6004</b>	150	290	480	1 900	3 900
	47	14	13,5	6,55	<b>6204</b>	130	270	450	1 800	3 600
	52	15	16,8	7,8	<b>6304</b>	130	250	420	1 700	3 300
<b>25</b>	47	12	11,9	6,55	<b>6005</b>	130	250	420	1 700	3 300
	52	15	14,8	7,8	<b>6205</b>	120	230	390	1 600	3 100
	62	17	23,4	11,6	<b>6305</b>	100	210	340	1 400	2 800
<b>30</b>	55	13	13,8	8,3	<b>6006</b>	110	210	350	1 400	2 800
	62	16	20,3	11,2	<b>6206</b>	100	200	330	1 300	2 600
	72	19	29,6	16	<b>6306</b>	90	180	290	1 200	2 400
<b>35</b>	62	14	16,8	10,2	<b>6007</b>	90	190	310	1 200	2 500
	72	17	27	15,3	<b>6207</b>	80	170	280	1 100	2 200
	80	21	35,1	19	<b>6307</b>	80	160	260	1 000	2 100
<b>40</b>	68	15	17,8	11,6	<b>6008</b>	80	170	280	1 100	2 200
	80	18	32,5	19	<b>6208</b>	80	150	250	1 000	2 000
	90	23	42,3	24	<b>6308</b>	70	140	230	920	1 800
<b>45</b>	75	16	22,1	14,6	<b>6009</b>	80	150	250	1 000	2 000
	85	19	35,1	21,6	<b>6209</b>	70	140	230	920	1 800
	100	25	55,3	31,5	<b>6309</b>	60	120	210	830	1 700
<b>50</b>	80	16	22,9	16	<b>6010</b>	70	140	230	920	1 800
	90	20	37,1	23,2	<b>6210</b>	60	130	210	860	1 700
	110	27	65	38	<b>6310</b>	60	110	190	750	1 500

<sup>1)</sup> If clearance larger than C3, consult **diagram 1 to 3 on page 10** for limiting speed reduction factors. Additional dimensions and CAD models of bearings are available for download from [www.skf.com/bearings](http://www.skf.com/bearings)

Principal dimensions			Basic load ratings		Designations Base bearings	Limiting speed		SKF DryLube bearings <sup>1)</sup>		
d	D	B	C	dynamic C <sub>0</sub>		static C <sub>0</sub>	Extreme temperature bearings VA208	VA201 VA228	VA210 VA260	VA2101 VA261
mm			kN			r/min				
55	90	18	29,6	21,2	<b>6011</b>	60	120	210	830	1 700
	100	21	46,2	29	<b>6211</b>	60	120	190	770	1 500
	120	29	74,1	45	<b>6311</b>	50	100	170	690	1 400
60	95	18	30,7	23,2	<b>6012</b>	60	120	190	770	1 500
	110	22	55,3	36	<b>6212</b>	50	110	180	710	1 400
	130	31	85,2	52	<b>6312</b>	50	90	160	630	1 300
65	100	18	31,9	25	<b>6013</b>	50	110	180	730	1 500
	120	23	58,5	40,5	<b>6213</b>	50	100	160	650	1 300
	140	33	97,5	60	<b>6313</b>	40	90	150	590	1 200
70	110	20	39,7	31	<b>6014</b>	50	100	170	670	1 300
	125	24	63,7	45	<b>6214</b>	50	90	150	620	1 200
	150	35	111	68	<b>6314</b>	40	80	140	550	1 100
75	115	20	41,6	33,5	<b>6015</b>	50	90	160	630	1 300
	130	25	68,9	49	<b>6215</b>	40	90	150	590	1 200
	160	37	119	76,5	<b>6315</b>	40	80	130	510	1 000
80	125	22	49,4	40	<b>6016</b>	40	90	150	590	1 200
	140	26	72,8	55	<b>6216</b>	40	80	140	550	1 100
	170	39	130	86,5	<b>6316</b>	40	70	120	480	960
85	130	22	52	43	<b>6017</b>	40	80	140	560	1 100
	150	28	87,1	64	<b>6217</b>	40	80	130	510	1 000
	180	41	140	96,5	<b>6317</b>	30	70	110	450	910
90	140	24	60,5	50	<b>6018</b>	40	80	130	520	1 000
	160	30	101	73,5	<b>6218</b>	40	70	120	480	960
	190	43	151	108	<b>6318</b>	30	60	110	430	860
95	145	24	63,7	54	<b>6019</b>	40	80	130	500	1 000
	170	32	114	81,5	<b>6219</b>	30	70	110	450	910
	200	45	159	118	<b>6319</b>	30	60	100	410	810
100	150	24	63,7	54	<b>6020</b>	40	70	120	480	960
	180	34	127	93	<b>6220</b>	30	60	110	430	860
	215	47	174	140	<b>6320</b>	30	60	100	380	760
110	170	28	85,2	73,5	<b>6022</b>	30	60	110	430	860
	200	38	151	118	<b>6222</b>	30	60	100	390	770
	240	50	203	180	<b>6322</b>	30	50	90	340	690
120	180	28	88,4	80	<b>6024</b>	30	60	100	400	800
	215	40	146	118	<b>6224</b>	30	50	90	360	720
	260	55	208	186	<b>6324</b>	20	50	80	320	630

Y-bearings, SKF DryLube bearings and extreme temperature bearings, metric and inch shafts

d 20 – 75 mm

d 3/4 – 2 7/16 in.

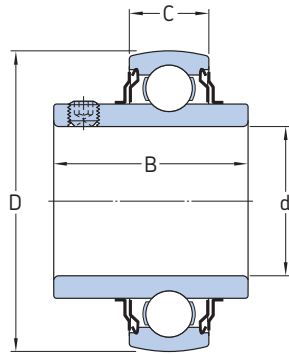

VA201

SKF extreme temperature bearings

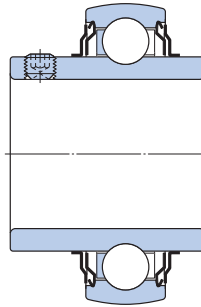

VA228

SKF DryLube bearings

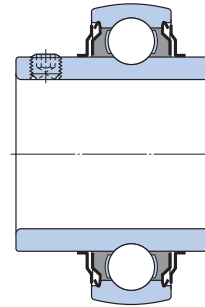

VA21...

Principal dimensions			Basic load ratings		Designations Base bearings	Limiting speed			
d	D	B	C	dynamic C <sub>0</sub>		Extreme temperature bearings VA201 VA228	SKF DryLube bearings <sup>1)</sup> VA210 VA2101 VA237 VA260 VA261 VA267		
mm			kN		r/min				
20	47	31	13,5	6,55	<b>YAR 204-2FW</b>	270	450	1 800	3 600
25	52	34,1	14,8	7,8	<b>YAR 205-2FW</b>	230	390	1 600	3 100
30	62	38,1	20,3	11,2	<b>YAR 206-2FW</b>	200	330	1 300	2 600
35	72	42,9	27	15,3	<b>YAR 207-2FW</b>	170	280	1 100	2 200
40	80	49,2	32,5	19	<b>YAR 208-2FW</b>	150	250	1 000	2 000
45	85	49,2	35,1	21,6	<b>YAR 209-2FW</b>	140	230	920	1 800
50	90	51,6	37,1	23,2	<b>YAR 210-2FW</b>	130	210	860	1 700
55	100	55,6	46,2	29	<b>YAR 211-2FW</b>	120	190	770	1 500
60	110	65,1	55,3	36	<b>YAR 212-2FW</b>	110	180	710	1 400
75	130	73,1	68,9	49	<b>YAR 215-2FW</b>	90	150	590	1 200
in.	mm	kN		r/min					
3/4	47	31	14	6,55	<b>YAR 204-012-2FW</b>	270	450	1 800	3 600
1	52	34,1	15	7,8	<b>YAR 205-100-2FW</b>	230	390	1 600	3 100
1 3/16	62	38,1	18	11,2	<b>YAR 206-103-2FW</b>	190	330	1 300	2 600
1 1/4	72	42,9	19	15,3	<b>YAR 207-104-2FW</b>	170	280	1 100	2 200
1 7/16	72	42,9	19	15,3	<b>YAR 207-107-2FW</b>	170	280	1 100	2 200
1 1/2	80	49,2	21	19	<b>YAR 208-108-2FW</b>	150	250	1 000	2 000
1 11/16	85	49,2	22	21,6	<b>YAR 209-111-2FW</b>	140	230	920	1 800
1 3/4	85	49,2	22	21,6	<b>YAR 209-112-2FW</b>	140	230	920	1 800
1 15/16	90	51,6	22	23,2	<b>YAR 210-115-2FW</b>	130	210	860	1 700
2	100	55,6	25	29	<b>YAR 211-200-2FW</b>	120	190	770	1 500
2 3/16	100	55,6	25	29	<b>YAR 211-203-2FW</b>	120	190	770	1 500
2 7/16	110	65,1	26	36	<b>YAR 212-207-2FW</b>	110	180	710	1 400

Virtually any SKF bearing is available as SKF DryLube bearings. For other series, sizes and designs, please contact SKF application engineering service or SKF Interactive Engineering Catalogue on [www.skf.com/bearings](http://www.skf.com/bearings)

<sup>1)</sup> If clearance greater than C3, consult diagram 1 to 3 on page 10 for limiting speed reduction factors. Additional dimensions and CAD models of bearings are available for download from [www.skf.com/bearings](http://www.skf.com/bearings)





# SKF – the knowledge engineering company

From the company that invented the self-aligning ball bearing more than 100 years ago, SKF has evolved into a knowledge engineering company that is able to draw on five technology platforms to create unique solutions for its customers. These platforms include bearings, bearing units and seals, of course, but extend to other areas including: lubricants and lubrication systems, critical for long bearing life in many applications; mechatronics that combine mechanical and electronics knowledge into systems for more effective linear motion and sensorized solutions; and a full range of services, from design and logistics support to condition monitoring and reliability systems.

Though the scope has broadened, SKF continues to maintain the world's leadership in the design, manufacture and marketing of rolling bearings, as well as complementary products such as radial seals. SKF also holds an increasingly important position in the market for linear motion products, high-precision aerospace bearings, machine tool spindles and plant maintenance services.

The SKF Group is globally certified to ISO 14001, the international standard for environmental management, as well as OHSAS 18001, the health and safety management standard. Individual divisions have been approved for quality certification in accordance with ISO 9001 and other customer specific requirements.

With over 120 manufacturing sites worldwide and sales companies in 70 countries, SKF is a truly international corporation. In addition, our distributors and dealers in some 15 000 locations around the world, an e-business marketplace and a global distribution system put SKF close to customers for the supply of both products and services. In essence, SKF solutions are available wherever and whenever customers need them. Overall, the SKF brand and the corporation are stronger than ever. As the knowledge engineering company, we stand ready to serve you with world-class product competencies, intellectual resources, and the vision to help you succeed.



© Airbus – photo: e\*im company, H. Goussé

## **Evolving by-wire technology**

SKF has a unique expertise in the fast-growing by-wire technology, from fly-by-wire, to drive-by-wire, to work-by-wire. SKF pioneered practical fly-by-wire technology and is a close working partner with all aerospace industry leaders. As an example, virtually all aircraft of the Airbus design use SKF by-wire systems for cockpit flight control.

SKF is also a leader in automotive by-wire technology, and has partnered with automotive engineers to develop two concept cars, which employ SKF mechatronics for steering and braking. Further by-wire development has led SKF to produce an all-electric forklift truck, which uses mechatronics rather than hydraulics for all controls.

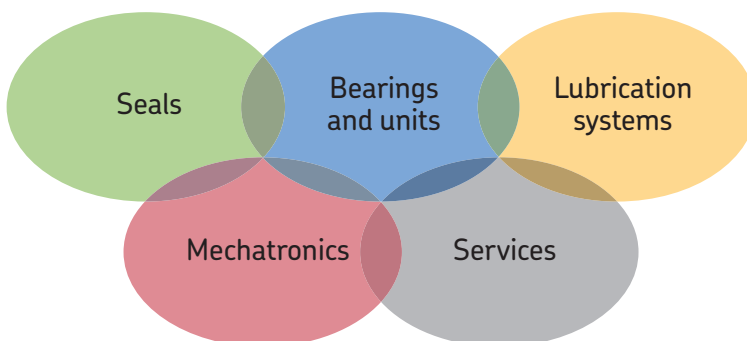



#### **Harnessing wind power**

The growing industry of wind-generated electric power provides a source of clean, green electricity. SKF is working closely with global industry leaders to develop efficient and trouble-free turbines, providing a wide range of large, highly specialized bearings and condition monitoring systems to extend equipment life of wind farms located in even the most remote and inhospitable environments.



#### **Working in extreme environments**

In frigid winters, especially in northern countries, extreme sub-zero temperatures can cause bearings in railway axleboxes to seize due to lubrication starvation. SKF created a new family of synthetic lubricants formulated to retain their lubrication viscosity even at these extreme temperatures. SKF knowledge enables manufacturers and end user customers to overcome the performance issues resulting from extreme temperatures, whether hot or cold. For example, SKF products are at work in diverse environments such as baking ovens and instant freezing in food processing plants.



#### **Developing a cleaner cleaner**

The electric motor and its bearings are the heart of many household appliances. SKF works closely with appliance manufacturers to improve their products' performance, cut costs, reduce weight, and reduce energy consumption. A recent example of this cooperation is a new generation of vacuum cleaners with substantially more suction. SKF knowledge in the area of small bearing technology is also applied to manufacturers of power tools and office equipment.



#### **Maintaining a 350 km/h R&D lab**

In addition to SKF's renowned research and development facilities in Europe and the United States, Formula One car racing provides a unique environment for SKF to push the limits of bearing technology. For over 60 years, SKF products, engineering and knowledge have helped make Scuderia Ferrari a formidable force in F1 racing. (The average racing Ferrari utilizes around 150 SKF components.) Lessons learned here are applied to the products we provide to automakers and the aftermarket worldwide.



#### **Delivering Asset Efficiency Optimization**

Through SKF Reliability Systems, SKF provides a comprehensive range of asset efficiency products and services, from condition monitoring hardware and software to maintenance strategies, engineering assistance and machine reliability programmes. To optimize efficiency and boost productivity, some industrial facilities opt for an Integrated Maintenance Solution, in which SKF delivers all services under one fixed-fee, performance-based contract.



#### **Planning for sustainable growth**

By their very nature, bearings make a positive contribution to the natural environment, enabling machinery to operate more efficiently, consume less power, and require less lubrication. By raising the performance bar for our own products, SKF is enabling a new generation of high-efficiency products and equipment. With an eye to the future and the world we will leave to our children, the SKF Group policy on environment, health and safety, as well as the manufacturing techniques, are planned and implemented to help protect and preserve the earth's limited natural resources. We remain committed to sustainable, environmentally responsible growth.

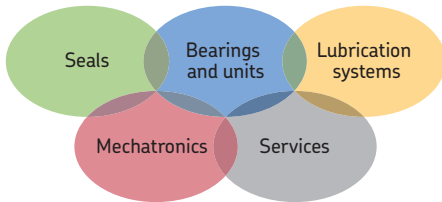

### The Power of Knowledge Engineering

Drawing on five areas of competence and application-specific expertise amassed over more than 100 years, SKF brings innovative solutions to OEMs and production facilities in every major industry worldwide. These five competence areas include bearings and units, seals, lubrication systems, mechatronics (combining mechanics and electronics into intelligent systems), and a wide range of services, from 3-D computer modelling to advanced condition monitoring and reliability and asset management systems. A global presence provides SKF customers uniform quality standards and worldwide product availability.



Download the complete content of this product brochure to your smartphone using this QR-code.

© SKF is a registered trademark of the SKF Group.

© SKF Group 2012

The contents of this publication are the copyright of the publisher and may not be reproduced (even extracts) unless prior written permission is granted. Every care has been taken to ensure the accuracy of the information contained in this publication but no liability can be accepted for any loss or damage whether direct, indirect or consequential arising out of the use of the information contained herein.

PUB BU/P2 11358/3 EN · August 2012

Certain image(s) used under license from Shutterstock.com

